

vtech®

User's manual

www.vtechphones.com



Models:

CS6428-2/CS6429/
CS6429-16/CS6429-2/
CS6429-3/CS6429-4/
CS6429-5



DECT 6.0

Congratulations

on purchasing your new VTech product. Before using this telephone, please read **Important safety instructions** on page 61 of this manual.

This manual has all the feature operations and troubleshooting necessary to install and operate your new VTech telephone. Please review this manual thoroughly to ensure proper installation and operation of this innovative and feature rich VTech product. For support, shopping, and everything new at VTech, visit our website at www.vtechphones.com. In Canada, please visit www.vtechcanada.com.



Telephones identified with this logo have reduced noise and interference when used with most T-coil equipped hearing aids and cochlear implants. The TIA-1083 Compliant Logo is a trademark of the Telecommunications Industry Association. Used under license.

Register online to get an additional 3-month warranty!

Visit www.vtechphones.com.



Registration

Register your product online for enhanced warranty support.



Product news

Learn about the latest VTech products.

Table of contents

Getting started	1	Review and dial a redial entry	20
Parts checklist	1	Store a number from the redial list to the directory	20
Telephone base and charger installation	2	Delete a redial entry	20
Battery installation	3	Chain dialing.....	21
Battery charging	5	Join a call in progress.....	22
Installation options.....	6	Find handset.....	22
Rewiring of telephone line for cable/VoIP service users.....	8	Intercom.....	23
Telephone base layout	9	Answer an incoming call during an intercom call	24
Handset layout	10	Call transfer using intercom.....	24
Telephone settings	12	Directory	26
Using the menu	12	About the directory	26
Ringer volume (telephone base) ...	12	Create a new directory entry	27
Ringer volume (handset)	13	Review the directory	29
Ringer tone.....	13	Alphabetical search	29
LCD language.....	14	Dial a directory entry.....	29
Clear voicemail indicators.....	15	Edit a directory entry.....	29
Key tone	15	Delete a directory entry	29
Set date and time	16	Speed dial.....	30
Home area code	17	Store a speed dial entry.....	30
Dial mode	17	Dial a speed dial number.....	31
Telephone operation	18	Delete a speed dial entry.....	31
Make a call	18	Caller ID	32
Predial a call.....	18	About caller ID	32
Answer a call	18	Information about caller ID with call waiting.....	32
End a call.....	18	Call log.....	33
Speakerphone	18	Missed call indicator	34
Volume	18	Memory match.....	34
Mute.....	19	Review and dial from the call log...	34
Call waiting	19	View dialing options.....	35
Temporary ringer silencing	19	Save a call log entry to the directory	35
Temporary tone dialing.....	19		
Redial list.....	20		

Table of contents

Delete from the call log.....	36
Call log display screen messages .	36
Answering system settings.....	37
Answering system setup.....	37
Answer on/off.....	37
Announcement	37
Record a new announcement.....	38
Play the announcement.....	38
Delete your announcement	38
Call screening.....	39
Number of rings	39
Remote access code	39
Message alert tone	40
Recording time	40
Answering system operation	41
Answering system and voicemail indicators.....	41
Using the answering machine and voicemail together	41
Voice prompts.....	42
Message capacity.....	42
Answering system new message indication.....	42
Call screening at the telephone base	42
Call screening at the handset.....	43
Call intercept.....	43
Message playback.....	43
Delete all old messages	45
Record, play or delete memos.....	46
Message window displays	47
Remote access.....	48
Appendix	49
Handset display screen messages.....	49
Handset and telephone base indicators.....	51
Expand your telephone system	52
Troubleshooting.....	53
Important safety instructions.....	61
Operating range.....	63
Maintenance	63
The RBRC® seal	64
FCC, ACTA and IC regulations	65
California Energy Commission battery charging testing instructions	67
For C-UL compliance only.....	68
Limited warranty	71
Technical specifications.....	73
Index	74

Getting started

Parts checklist

Your telephone package contains the following items. Save your sales receipt and original packaging in case it is necessary to ship your telephone for warranty service.



Battery compartment cover

(1 for CS6429/CS6429-16)
(2 for CS6428-2/CS6429-2)
(3 for CS6429-3)
(4 for CS6429-4)
(5 for CS6429-5)



Battery

(1 for CS6429/CS6429-16)
(2 for CS6428-2/CS6429-2)
(3 for CS6429-3)
(4 for CS6429-4)
(5 for CS6429-5)



Telephone line cord

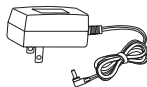

Telephone base power adapter



Handset

(1 for CS6429/CS6429-16)
(2 for CS6428-2/CS6429-2)
(3 for CS6429-3)
(4 for CS6429-4)
(5 for CS6429-5)

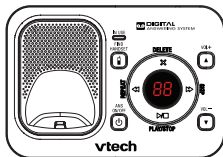

Telephone base

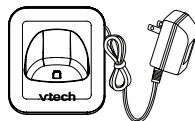

Charger and charger adapter

(1 for CS6428-2/CS6429-2)
(2 for CS6429-3)
(3 for CS6429-4)
(4 for CS6429-5)

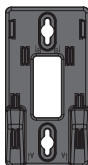

Wall mount bracket

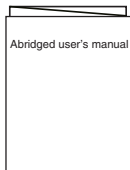

Abridged user's manual

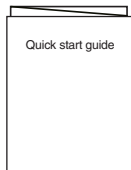

Quick start guide

note

To purchase replacement batteries or power adapters, visit our website at www.vtechphones.com or call 1 (800) 595-9511. In Canada, go to www.vtechcanada.com or call 1 (800) 267-7377.

Getting started

Telephone base and charger installation

Install the telephone base and charger(s) as shown below.

If you subscribe to digital subscriber line (DSL) high-speed Internet service through your telephone line, you must install a DSL filter between the telephone line cord and the telephone wall jack. Contact your DSL service provider for more information about DSL filters.

The telephone base comes ready for tabletop use. If you want to mount your telephone on a wall, refer to **Tabletop to wall mount installation** on page 6 for details.

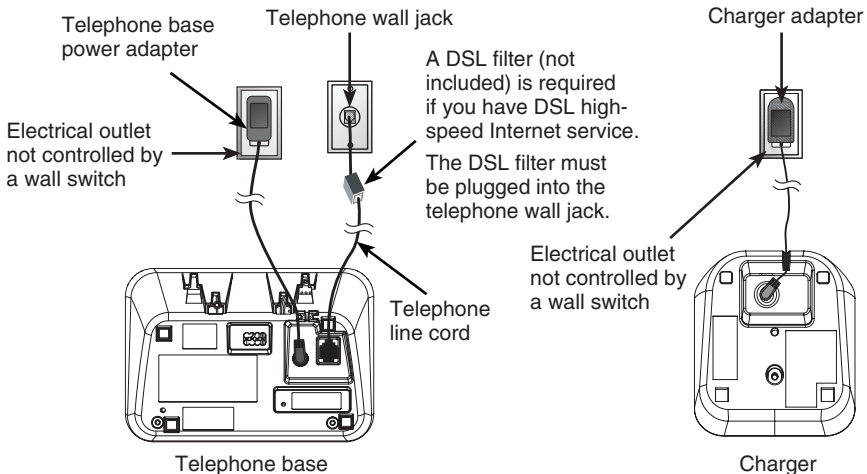

CAUTION: If you subscribe to telephone service from a cable company or a VoIP service provider, plug the telephone line cord into the modem/router/terminal adapter provided by your cable/VoIP service provider. Contact your cable/VoIP service provider if you have any difficulties in installation.

note

- Use only the power adapters supplied with this product. To order a replacement, visit our website at www.vtechphones.com or call 1 (800) 595-9511. In Canada, go to www.vtechcanada.com or dial 1 (800) 267-7377.
- The power adapters are intended to be correctly oriented in a vertical or floor mount position. The prongs are not designed to hold the plug in place if it is plugged into a ceiling, under-the-table or cabinet outlet.

Getting started

Battery installation

Install the battery as shown below.

1. Plug the battery connector securely into the socket inside the handset battery compartment.

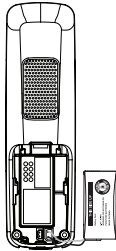

2. Place the battery with the label **THIS SIDE UP** facing up and the wires inside the battery compartment.

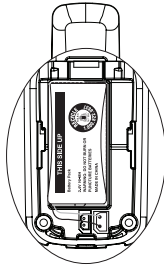

3. Align the cover flat against the battery compartment, then slide it towards the center of the handset until it clicks into place.

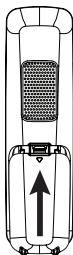

Getting started

Battery installation (continued)

- Charge the handset by placing it in the telephone base or charger. The **CHARGE** light is on when the handset is charging.

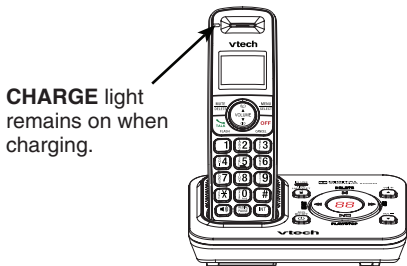

IMPORTANT:

Check for a dial tone by pressing . If you hear a dial tone, the installation is successful.

If you do not hear a dial tone:

- Make sure the installation procedures described above are properly done.
- It may be a wiring problem. If you have changed your telephone service to digital service from a cable company or a VoIP service provider, the telephone line may need to be rewired to allow all existing telephone jacks to work. Refer to **Rewiring of telephone line for cable/VoIP service users** on page 8 for more information.

note

- If the handset will not be used for a long time, disconnect and remove the battery to prevent possible leakage.
- To purchase replacement batteries, visit our website at www.vtechphones.com or call 1 (800) 595-9511. In Canada, go to www.vtechcanada.com or dial 1 (800) 267-7377.



Getting started

Battery charging

Once you have installed the battery, the screen indicates the battery status (see the table below).

note

- For best performance, keep the handset in the telephone base or charger when not in use.
- The battery is fully charged after 10 hours of continuous charging.
- If you place the handset in the telephone base or the charger without plugging in the battery, the screen displays **NO BATTERY**.

Battery indicators	Battery status	Action
The screen is blank, or displays PLACE IN CHARGER and  flashes.	Battery has no or very little charge. The handset cannot be used.	Charge without interruption (about 30 minutes).
The screen displays LOW BATTERY and  flashes.	Battery has enough charge to be used for a short time.	Charge without interruption (about 30 minutes).
The screen displays HANDSET X .	Battery is charged.	To keep the battery charged, place it in the telephone base or charger when not in use.

When the battery is fully charged, you can expect the following performance:

Operation	Operating time
While in handset use (talking*)	Up to seven hours
While in speakerphone mode (talking*)	Up to four hours
While not in use (standby**)	Up to five days

*Operating times vary depending on your actual use and the age of the battery.

**Handset is not charging or in use.

After you install your telephone or power returns following a power outage, the handset will prompt you to set the date and time. For instructions, see **Set date and time** on page 16. To skip setting the date and time, press **OFF/CANCEL**.



Getting started

Installation options

The telephone comes ready for tabletop use. If you want to mount your telephone on a wall, use the provided wall mount bracket to connect with a standard dual-stud telephone wall mount plate. If you do not have this wall mount plate, you can purchase one from many hardware or consumer electronics retailers. You may need a professional to install the wall mount plate.

Tabletop to wall mount installation

1. Plug one end of the telephone line cord into the **TEL LINE** jack on the bottom of the telephone base. Plug the small end of the base power adapter into the **POWER** jack on the bottom of the telephone base.
2. Position the telephone base against the wall mount bracket. Insert the extend tabs (marked **B**) of the wall mount bracket into the slots (marked **B**) on the back of the telephone base. Push the telephone base down until it clicks securely in place.
3. Route the telephone line cord (or DSL filter) through the hole in the middle of the wall mount bracket and plug it into the telephone wall jack. Route the power cord out of the bottom of the telephone and plug it into an electrical outlet not controlled by a wall switch.
4. Align the holes on the bracket with the standard wall mount plate and slide the bracket down until it locks securely. Bundle the telephone line cord and power adapter cord neatly with twist ties.

①

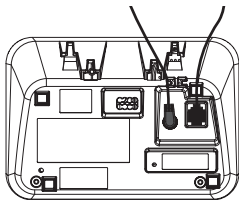

②

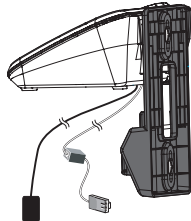

③

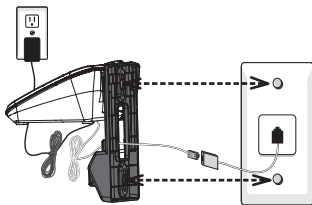

④

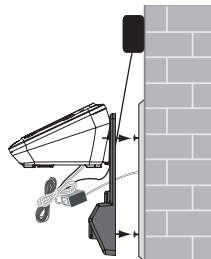

Getting started

Installation options (continued)

Wall mount to tabletop installation

1. If the telephone line cord and power adapter cord are bundled, untie them first.
2. Slide the black wall mount bracket up and remove it from the wall mount plate. Unplug the end of the telephone line cord (or DSL filter) from the telephone wall jack. Unplug the power adapter from the power outlet.
3. Slide the telephone base up and remove it from the wall mount bracket.
4. See **Telephone base and charger installation** on page 2.

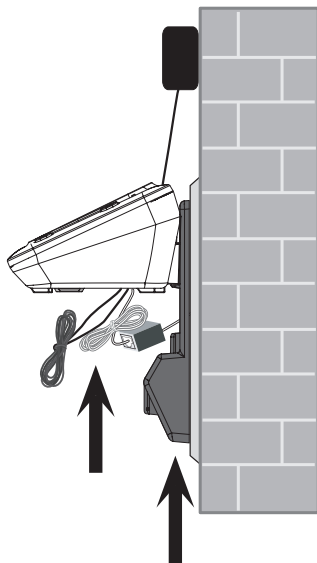

Getting started

Rewiring of telephone line for cable/VoIP service users

If you have changed to cable/VoIP service through a modem/router/terminal adapter to establish telephone connection, the existing telephone jacks in your home may no longer work. Your cable/VoIP service provider uses a separate cable connecting from the main line to the modem installed in your home.

To allow all existing telephone jacks to work, rewiring of the telephone line (as indicated by the dotted line in the illustration below) may be needed. Rewiring requires professional installation (fees may apply). Contact your cable/VoIP service provider for more information.

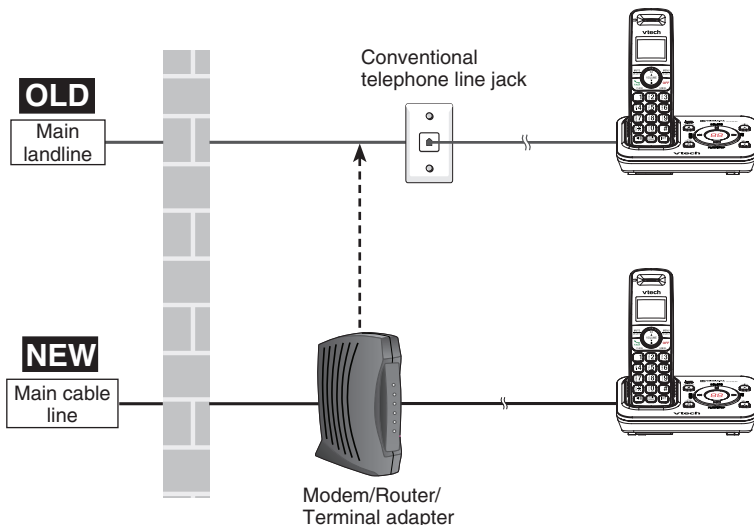

Getting started

Telephone base layout

X/DELETE

Press to delete the message currently playing (page 44).

When the telephone is not in use, press twice to delete all previously reviewed messages (page 45).

IN USE light

Flashes when there is an incoming call, or another telephone sharing the same line is in use.

On when the handset is in use, or the answering system is answering a call.

FIND HANDSET

Press once and then release to page all system handsets (page 22).

ANS ON/OFF

Press to turn the answering system on or off (page 37).

REPEAT

Press to repeat a message or press twice to play the previous message (page 44).

Message window

Shows the number of messages and other answering system information (page 47).

SKIP

Press to skip to the next message (page 44).

VOL+ and VOL-

Press to adjust the volume during message playback (page 44).

When the phone is not in use, press to adjust the telephone base ringer volume (page 12).

PLAY/STOP

Press to play messages (page 44).

Press to stop message playback (page 44).

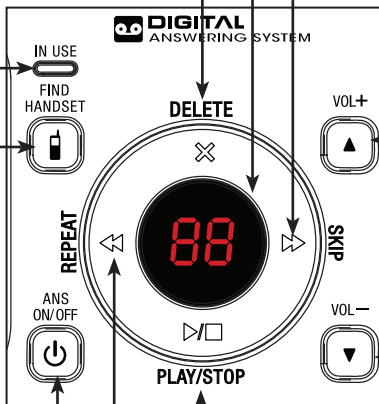

Getting started

Handset layout

CHARGE light

On when the handset is charging in the telephone base or charger (page 4).

VOLUME

Press to enter the directory when the telephone is not in use (page 29).

Press to scroll up while in a menu, or in the directory, call log or redial list.

During a call or message playback, press to increase the listening volume (page 18 or page 44).

When entering numbers or names in the directory, press to move the cursor to the right.

MUTE/DELETE

While on a call, press to mute the microphone (page 19).

While using the dialing keys, press to delete digits or characters.

While the handset is ringing, press to silence the ringer temporarily (page 19).

While reviewing the redial list, directory or call log, press to delete an individual entry (pages 20, 29 and 36 respectively).

/FLASH

Press to make or answer a call (page 18).

During a call, press to answer an incoming call when you receive a call waiting alert (page 19).

1

While reviewing a call log entry, press repeatedly to add or remove 1 in front of the call log entry before dialing or saving it to the directory.

TONEX

Press to switch to tone dialing temporarily when using the pulse service (page 19).

(speakerphone)

Press to make or answer a call.

During a call, press to switch between the speakerphone and the handset (page 18).

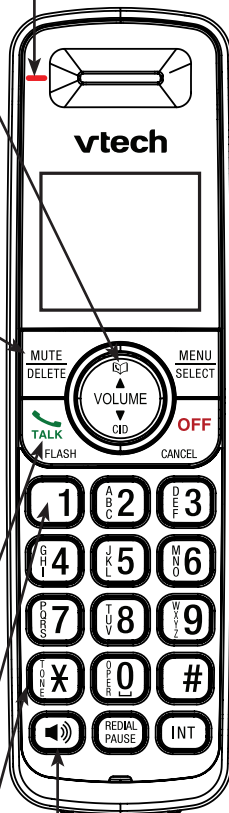

Getting started

Handset layout

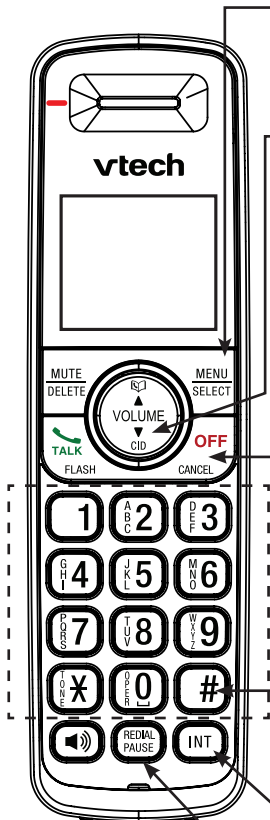

MENU/SELECT

Press to show the menu.

While in a menu, press to select an item, or save an entry or setting.

CID▼/VOLUME

Press to review the call log when the telephone is not in use (page 34).

Press to scroll down while in a menu, or in the directory, call log or redial list.

During a call or message playback, press to decrease the listening volume (page 18 or page 44).

When entering numbers or names in the directory, press to move the cursor to the left.

OFF/CANCEL

During a call, press to hang up.

While the handset is ringing, press to silence the ringer temporarily (page 19).

While the telephone is not in use, press and hold to erase the missed call indicator (page 34).

While in a menu, press to exit to the previous menu or press and hold to exit to idle mode.

(pound key)

Press repeatedly to show other dialing options when reviewing a call log entry (page 35).

Dialing keys

Press to enter numbers or characters.

INT (intercom)

Press to start an intercom conversation or transfer a call (pages 23-25).

REDIAL/PAUSE

Press to review the redial list (page 20).

While dialing or entering numbers into the directory, press and hold to insert a dialing pause.

Telephone settings

Using the menu

In the ringers menu, you can select the ringer tones and adjust the ringer volume for incoming calls.

In the settings menu, you can change and edit the settings for LCD language, voicemail indicators, key tone, date and time, home area code and dial mode.

Go to **Answering system settings** starting on page 37 for instructions on how to modify the answering system settings with a system handset shown in the table below.

Setting	Page
Answer on/off	37
Announcement (play, record and delete)	38
Call screening	39
Number of rings	39
Remote access code	39
Message alert tone	40
Recording time	40

To enter the handset menu:

1. Press **MENU/SELECT** when the handset is not in use.
 2. Press **▼** or **▲** until the screen displays the desired feature menu.
 3. Press **MENU/SELECT** to enter that menu.
- To return to the previous menu, press **OFF/CANCEL**.
 - To return to idle mode, press and hold **OFF/CANCEL**.

Ringer volume (telephone base)

Press **▲/VOL+** or **▼/VOL-** on the telephone base to adjust the ringer volume when the telephone is not in use. When you set the ringer volume to zero, the base ringer is off and the system announces, “*Base ringer is off.*”

Telephone settings

Ringer volume (handset)

You can adjust the ringer volume or turn the ringer off.

1. Press **MENU/SELECT** when the handset is not in use.
2. Press ▼ or ▲ to select >**RINGERS**, then press **MENU/SELECT**.
3. Press ▼ or ▲ to select >**RINGER VOLUME**, then press **MENU/SELECT**.
4. Press ▼ or ▲ to adjust the volume. A sample of each ringer volume plays as you scroll through the choices.
5. Press **MENU/SELECT** to save your selection. You hear a confirmation tone.

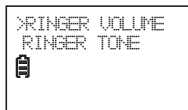
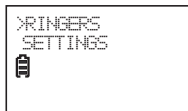

note

- The ringer volume also determines the ringer volume of the intercom calls and the volume of paging tone.
- When the handset ringer volume is set to off, that handset is silenced for all incoming calls except paging tone and  displays on the handset.
- Unless the ringer volume is turned off on that handset, each handset rings when there is an incoming call.

Ringer tone

You can choose from different ringer tones.

1. Press **MENU/SELECT** when the handset is not in use.
2. Press ▼ or ▲ to select >**RINGERS**, then press **MENU/SELECT**.
3. Press ▼ or ▲ to select >**RINGER TONE**, then press **MENU/SELECT**.
4. Press ▼ or ▲ to select a desired ringer tone. A sample of each ringer tone plays as you scroll through the choices.
5. Press **MENU/SELECT** to save your selection. You hear a confirmation tone.

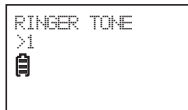
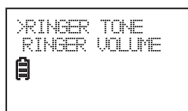

note

If you turn off the handset ringer volume, you will not hear ringer tone samples.

Telephone settings

LCD language

You can select a language (English, French or Spanish) to be used in all screen displays.

1. Press **MENU/SELECT** when the handset is not in use.
2. Press **▼** or **▲** to select **>SETTINGS**, then press **MENU/SELECT**.
3. Press **▼** or **▲** to select **>LCD LANGUAGE**, then press **MENU/SELECT**.
4. Press **▼** or **▲** to choose **ENGLISH, FRANÇAIS** or **ESPAÑOL**.
5. Press **MENU/SELECT** to save your selection. You hear a confirmation tone.



>LCD LANGUAGE
CLR VOICEMAIL



LCD LANGUAGE
>ENGLISH

Telephone settings

Clear voicemail indicators

If you subscribe to voicemail service offered by your telephone service provider, **NEW VOICEMAIL** and  appear on the handset when you have new voicemail messages. Contact your telephone service provider for more information about using your voicemail service.

After you have listened to all new voicemail messages, the indicators on the handset turn off automatically.

Use this feature when the telephone indicates that there is new voicemail but there are none (for example, when you have accessed your voicemail while away from home). This feature only turns off the indicators; it does not delete your voicemail messages. As long as you have new voicemail messages, your telephone service provider continues to send the signal to turn on the indicators.

To manually turn off these indicators:

1. Press **MENU/SELECT** when the handset is not in use.
2. Press **▼** or **▲** to select **>SETTINGS**, then press **MENU/SELECT**.
3. Press **▼** or **▲** to select **>CLR VOICEMAIL**, then press **MENU/SELECT**. The screen shows **TURN OFF INDICATOR?**
4. Press **MENU/SELECT** to save your selection. You hear a confirmation tone.

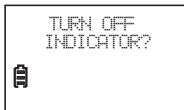

note

- Your telephone service provider may alert you of new messages with a stutter (broken) dial tone. Contact your telephone service provider for details.
- Voicemail is different from answering system messages recorded in your answering system. For more information about the difference, see page 41.

Key tone

You can turn the key tone on or off.

1. Press **MENU/SELECT** when the handset is not in use.
2. Press **▼** or **▲** to select **>SETTINGS**, then press **MENU/SELECT**.
3. Press **▼** or **▲** to select **>KEY TONE**, then press **MENU/SELECT**.
4. Press **▼** or **▲** to choose **ON** or **OFF**.
5. Press **MENU/SELECT** to save your selection. You hear a confirmation tone.

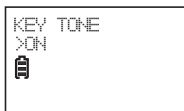
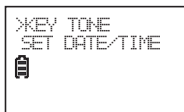

Telephone settings

Set date and time

The answering system announces the date and time of each message prior to playing it. If you subscribe to caller ID service, the day, month and time are set automatically with each incoming call. However, the year must be correct so that the day of the week can be calculated from the caller ID information. Before using the answering system, set the date and time.

1. Press **MENU/SELECT** when the handset is not in use.
2. Press **▼** or **▲** to select **>SETTINGS**, then press **MENU/SELECT**.
3. Press **▼** or **▲** to select **>SET DATE/TIME**, then press **MENU/SELECT**.
4. When the month is flashing, press **▼** or **▲** until the screen displays the correct month. Press **MENU/SELECT** to confirm.



>SET DATE/TIME
HOME AREA CODE
📞

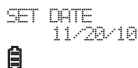

SET DATE
11/20/10
📞

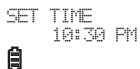

SET TIME
10:30 PM
📞

- OR-**
Press the dialing keys (**0-9**) to enter the current month (for example, if the month is March, you must enter **03**).
5. Repeat Step 4 to set the correct date and year and then press **MENU/SELECT** to advance to set the time.
 6. Repeat Step 4 until the time is set. Press **▼** or **▲** to choose **AM** or **PM**, or press **2** for **AM** or **7** for **PM**. Press **MENU/SELECT** to save your selection. You hear a confirmation tone.

note

If the date and time are not set, the system announces, “*Time and date not set,*” before each message plays.

Telephone settings

Home area code

If you dial your local calls using only seven digits (area code not required), you can program your home area code so that when you receive a call within your local area, the telephone number is automatically stored without the area code in the call log.

1. Press **MENU/SELECT** when the handset is not in use.
2. Press **▼** or **▲** to select **>SETTINGS**, then press **MENU/SELECT**.
3. Press **▼** or **▲** to select **>HOME AREA CODE**, then press **MENU/SELECT**.
4. Use the dialing keys to enter the desired home area code.
 - Press **MUTE/DELETE** to delete a digit.
 - Press and hold **MUTE/DELETE** to delete the entire entry.
5. Press **MENU/SELECT** to save the selection. You hear a confirmation tone.

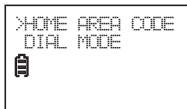

note

If, in the future, your telephone service provider requires you to dial the area code when making a local call, or, if you move to a location that requires it, delete the home area code you have already programmed, following the steps above. After you have deleted the home area code, ___ _ will appear in the display.

Dial mode

The default dial mode is tone dialing. If you have pulse (rotary) service, you need to change the dial mode to pulse dialing before using the telephone.

1. Press **MENU/SELECT** when the handset is not in use.
2. Press **▼** or **▲** to select **>SETTINGS**, then press **MENU/SELECT**.
3. Press **▼** or **▲** to select **>DIAL MODE**, then press **MENU/SELECT**.
4. Press **▼** or **▲** to choose **TONE** or **PULSE**.
5. Press **MENU/SELECT** to save your selection. You hear a confirmation tone.

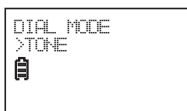
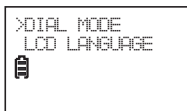

Telephone operation

Make a call

1. Press **TALK/FLASH**, then wait for a dial tone.

-OR-

Press **☎** to use the speakerphone, then wait for a dial tone.

2. Use the dialing keys to enter the telephone number.

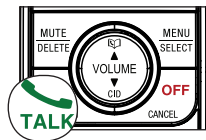

Predial a call

1. Use the dialing keys to enter the telephone number (up to 30 digits).
 - Press and hold **REDIAL/PAUSE** to insert a dialing pause (a **P** appears).
 - Press **MUTE/DELETE** or **OFF/CANCEL** to make corrections.
2. Press **TALK/FLASH** or **☎** to call.

Answer a call

Press **TALK/FLASH**, **☎** or any dialing key (**0-9**, **TONE~~X~~** or **#**).

End a call

Press **OFF/CANCEL** or put the handset in the telephone base or charger.

note

The screen shows the elapsed time as you talk (in hours, minutes and seconds).

Speakerphone

During a call, press **☎** to switch between speakerphone and normal handset use. When the speakerphone is active, the handset shows **SPEAKER** and **☎**.

Volume

During a call, press **▲/VOLUME** or **▼/VOLUME** to adjust the listening volume. When the volume reaches the minimum or maximum setting, you hear two beeps.

note

The handset earpiece volume setting and speakerphone volume setting are independent.

Telephone operation

Mute

The mute function allows you to hear the other party but the other party cannot hear you.

1. During a call, press **MUTE/DELETE** on the handset. The handset displays **MUTED** for a few seconds and **MUTE** appears until the mute function is turned off.
2. Press **MUTE/DELETE** again to resume the conversation. The handset screen temporarily shows **MICROPHONE ON**.

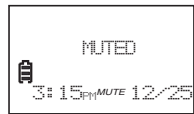
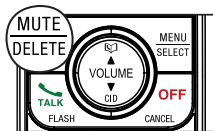

Call waiting

When you subscribe to call waiting service from your telephone service provider, you hear an alert tone if there is an incoming call while you are on another call.

- Press **TALK/FLASH** to put the current call on hold and take the new call.
- Press **TALK/FLASH** at any time to switch back and forth between calls.

Temporary ringer silencing

When the telephone is ringing, you can temporarily silence the ringer of the handset without disconnecting the call. The next call rings normally at the preset volume.

To silence the ringer:

When the telephone is ringing, press **OFF/CANCEL** or **MUTE/DELETE** on the handset, **RINGER MUTED** and  show on the screen.

Temporary tone dialing

If you have dial pulse (rotary) dialing service only, you can temporarily switch from dial pulse to touch-tone dialing during a call.

1. During a call, press **TONE~~X~~**.
2. Use the dialing keys to enter the number. The telephone sends touch-tone signals.
3. The telephone automatically returns to pulse dialing mode after you end the call.

Telephone operation

Redial list

Each handset stores the last 10 telephone numbers dialed.

When there are already 10 redial entries, the oldest entry is deleted to make room for the new entry.

Entries are shown in reverse chronological order.

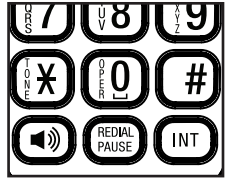

Review and dial a redial entry

1. Press **REDIAL/PAUSE** when the handset is not in use.
2. Press **▼**, **▲** or **REDIAL/PAUSE** repeatedly to browse. The handset beeps twice at the beginning or end of the list.
3. Press **TALK/FLASH** or **📞** to dial.

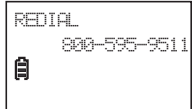

-OR-

1. Press **TALK/FLASH** or **📞** and then wait for a dial tone.
2. Press **REDIAL/PAUSE** and then press **▼**, **▲** or **REDIAL/PAUSE** repeatedly to browse.
3. When the desired entry displays, press **MENU/SELECT** to dial.

Store a number from the redial list to the directory

1. When the desired number in the redial list displays, press **MENU/SELECT** twice.
2. Follow Step 3 to Step 6 in **Create a new directory entry** on page 28.

Delete a redial entry

1. Press **REDIAL/PAUSE** when the handset is not in use.
2. Press **▼**, **▲** or **REDIAL/PAUSE** repeatedly to browse to the desired entry.
3. Press **MUTE/DELETE** to delete the displayed number. You hear a confirmation tone.

Telephone operation

Chain dialing

Use this feature to initiate a dialing sequence from numbers stored in the directory, call log or redial while you are on a call.

Chain dialing can be useful if you wish to access other numbers (such as bank account numbers or access codes) from the directory, call log or redial list.

To access the directory while on a call:

1. Press **MENU/SELECT**.
2. Press **▼** or **▲** to scroll to **>DIRECTORY**, then press **MENU/SELECT**.
3. Press **▼** or **▲** to scroll or use the dialing keys (**0** through **9**) to find the desired entry (see **Alphabetical search** on page 29).
4. Press **MENU/SELECT** to dial the displayed number.

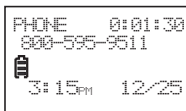

To access the call log while on a call:

1. Press **MENU/SELECT**.
2. Press **▼** or **▲** to scroll to **>CALL LOG**, then press **MENU/SELECT**.
3. Press **▼** or **▲** to scroll to the desired entry.
4. Press **MENU/SELECT** to dial the displayed number.

To access the redial list while on a call:

1. Press **REDIAL/PAUSE**.
2. Press **▼**, **▲** or **REDIAL/PAUSE** repeatedly to scroll to the desired number.
3. Press **MENU/SELECT** to dial the displayed number.

note

- You cannot edit a directory entry, copy a call log or redial entry into the directory while on a call.
- Press **OFF/CANCEL** to exit the directory, call log or redial list while on a call.

Telephone operation

Join a call in progress

You can use up to four system handsets at a time on an outside call. You can buy additional expansion handsets (**CS6409**) for this telephone base. You can register up to five handsets to the telephone base.

To join a call:

- When a handset is on a call, press **TALK/FLASH** or **⏸** on another handset.
- Press **OFF/CANCEL** to exit the call. The call continues until all handsets hang up.

Find handset

Use this feature to find all system handsets.

To start the paging tone:

- Press **FIND HANDSET** on the telephone base once and then release when the telephone is not in use. All idle handsets ring and their screens show **** PAGING****.

To end the paging tone:

- Press **FIND HANDSET** on the telephone base once and then release.
- Press **TALK/FLASH**, **⏸** or any dialing key (**0-9**, **TONE** or **#**) on the handset.
- Place the handset in the telephone base or charger.

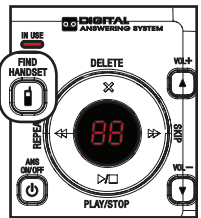

note

- Do not press and hold **FIND HANDSET** for more than four seconds. It may lead to handset deregistration. If **1.PRESS FIND HS ON BASE 4 SEC** and **2.THEN PRESS # ON HANDSET** display alternately on the handset, refer to Troubleshooting to register the handset to the telephone base.
- When you press **OFF/CANCEL** or **MUTE/DELETE** on a handset, the ringer of that handset is silenced but the paging tone continues on other handsets.
- You cannot use the find handset feature while the telephone base is playing messages or the answering system is being accessed remotely.

Telephone operation

Intercom

Use the intercom feature for conversations between two handsets.

1. Press **INT** on your handset when not in use.

- If you have two handsets, your handset shows **CALLING OTHER HANDSET**.
- If you have three or more handsets, your handset shows **INTERCOM TO:** Use the dialing keys to select a destination handset. Your handset shows **CALLING HANDSET X**.

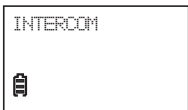
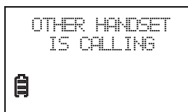
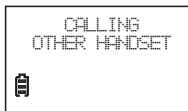

The destination handset rings and its screen shows **OTHER HANDSET IS CALLING** when you have two handsets, or **HANDSET X IS CALLING** when you have three or more handsets.

2. To answer the intercom call, press **TALK/FLASH**, **INT** or any dialing key (**0-9**, **TONE** or **#**) on the destination handset. Both handsets now show **INTERCOM**.
3. To end an intercom call, press **OFF/CANCEL** or place the handset back in the telephone base or charger. Both handsets now show **INTERCOM ENDED**.

note

- You can cancel the intercom call before it is answered by pressing **OFF/CANCEL** or **INT** on the originating handset.
- If the destination handset does not answer the intercom call within 100 seconds, is in the directory or call log, or is out of range, the originating handset shows **UNABLE TO CALL. TRY AGAIN** and returns to idle mode.
- Press **OFF/CANCEL** or **MUTE/DELETE** on the destination handset to temporarily silence the intercom ringer.
- You can use two pairs of handsets on two intercom calls at a time. When two pairs of handsets are used on intercom calls, use the fifth handset for an outside call.
- If there is an incoming call while the originating handset shows **INTERCOM TO:**, the intercom request will be stopped and the screen will show **INCOMING CALL**.

Telephone operation

Answer an incoming call during an intercom call

When you receive an outside call during an intercom call, there is an alert tone.

- To answer the incoming outside call, press **TALK/FLASH**. The intercom call ends automatically.
- To end the intercom call without answering the outside call, press **OFF/CANCEL**. The telephone continues to ring.

Call transfer using intercom

Use the intercom feature to transfer an outside call to another system handset.

1. During a call, press **INT**.

- If you have two handsets, the outside call is put on hold and your handset shows **CALLING OTHER HANDSET**.
- If you have three or more handsets, your handset shows **INTERCOM TO:** Use the dialing keys to enter a handset number. The outside call is put on hold and your handset shows **CALLING HANDSET X**.

The destination handset rings and its screen shows **OTHER HANDSET IS CALLING** when you have two handsets, or **HANDSET X IS CALLING** when you have three or more handsets.

2. To answer the intercom call on the destination handset, press **TALK/FLASH**, **INT** or any dialing key (**0-9**, **TONE X** or **#**). The outside call is still on hold and both handsets now show **INTERCOM**. You can now have a private conversation with the destination handset.

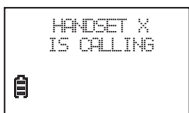
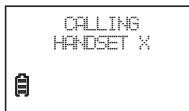
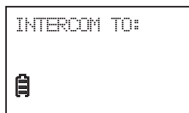

note

- To cancel the transfer and return to the outside call before the intercom call is answered, press **OFF/CANCEL**, **TALK/FLASH** or **INT** on your handset.
- If the other handset is not answered within 100 seconds, is in use, on a call or is out of range, the calling handset shows **UNABLE TO CALL. TRY AGAIN** and then reconnects to the outside call.

Telephone operation

Call transfer using intercom (continued)

3. From this intercom call, you have the following options:
 - You can let the destination handset join you on the outside call in a three-way conversation. Press and hold **INT** on the originating handset.
 - You can transfer the call. Press **OFF/CANCEL**, or place your handset back in the telephone base or charger. Your handset shows **CALL TRANSFERRED**. The destination handset is then connected to the outside call.
 - You can press **INT** to switch between the outside call (**OUTSIDE CALL** displays) and the intercom call (**INTERCOM** displays).
 - The destination handset can end the intercom call by pressing **OFF/CANCEL**, or by placing the handset back in the telephone base or charger. The outside call continues with the original system handset.

Directory

About the directory

The directory stores up to 50 entries with up to 30 digits for each phone number and 15 characters for each name.

- Directory entries are shared by all system handsets. Any modifications made on one handset apply to all system handsets.
- When you access the directory without records, the screen shows **DIRECTORY EMPTY**.
- When the directory is full and you try to save an entry, the screen shows **DIRECTORY FULL**.
- When you try to save an entry already stored in the directory, the screen shows **NUMBER ALREADY SAVED**.
- When the telephone number in the directory exceeds 15 digits, <*> appears in front of the telephone number. Press **TONEx** to move towards the end of the telephone number or press # (pound key) to move towards the beginning of the telephone number.
- Only one handset can review the directory at a time. When a handset tries to enter the directory while another handset is already in it, **NOT AVAILABLE AT THIS TIME** appears.

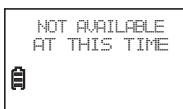
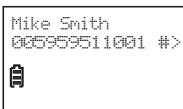
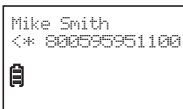
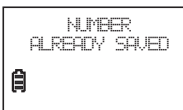
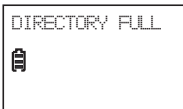

Directory

Create a new directory entry

1. Press **MENU/SELECT** when the handset is not in use.
2. Press **▼** or **▲** to select **>DIRECTORY** and then press **MENU/SELECT**.
3. Press **▼** or **▲** to select **>ADD CONTACT**, then press **MENU/SELECT**. The screen displays **ENTER NUMBER**.
4. Use the dialing keys to enter a number (up to 30 digits).
 - Press **MUTE/DELETE** to erase a digit.
 - Press and hold **MUTE/DELETE** to erase all digits.
 - Press **▼** or **▲** to move the cursor to the left or right.
 - Press and hold **REDIAL/PAUSE** to enter a dialing pause (a **P** appears).

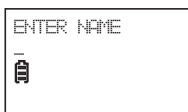
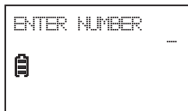
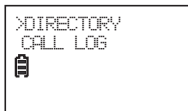

-OR-

Copy a number from the redial list by pressing **REDIAL/PAUSE** and then press **▼**, **▲** or **REDIAL/PAUSE** repeatedly to select a number. Press **MENU/SELECT** to edit the number.

5. Press **MENU/SELECT** to move to the name. The screen shows **ENTER NAME**.
6. Use the dialing keys to enter the name (up to 15 characters). Additional key presses show other characters of that particular key. Press the key repeatedly until the desired character appears. The first character and the character after a space are automatically capitalized.
 - Press **0** to add a space.
 - Press **▼** or **▲** to move the cursor to the left or right.
 - Press **MUTE/DELETE** to erase a character.
 - Press and hold **MUTE/DELETE** to erase all characters.
7. Press **MENU/SELECT** to save. The screen displays **SAVED** and then you hear a confirmation tone.

Directory

Create a new directory entry (continued)

-OR-

1. Enter the number when the handset is not in use.
2. Press **MENU/SELECT** and the screen displays **EDIT NUMBER**.
3. Use the dialing keys to edit the number.
 - Press **MUTE/DELETE** to erase a digit.
 - Press and hold **MUTE/DELETE** to erase all digits.
 - Press **▼** or **▲** to move the cursor to the left or right.
 - Press and hold **REDIAL/PAUSE** to enter a dialing pause (a **P** appears).
4. Press **MENU/SELECT** to move to the name. The screen shows **EDIT NAME**.
5. Use the dialing keys to enter the name. Additional key presses show other characters of that particular key. Press the key repeatedly until the desired character appears. The first character and the character after a space are automatically capitalized.
 - Press **0** to add a space.
 - Press **▼** or **▲** to move the cursor to the left or right.
 - Press **MUTE/DELETE** to erase a character.
 - Press and hold **MUTE/DELETE** to erase all characters.
6. Press **MENU/SELECT** to save. The screen displays **SAVED** and then you hear a confirmation tone.

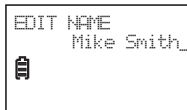
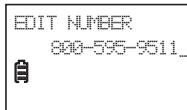







note

If you pause for too long while storing an entry, the procedure times out and you have to begin again.

Directory





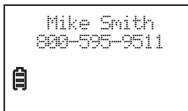

Review the directory

Entries are sorted alphabetically.



1. Press   when the handset is not in use.
-OR-
Press **MENU/SELECT** when the handset is not in use.
Press  or  to scroll to **>DIRECTORY**, then press **MENU/SELECT** twice.
2. Press  or  to browse.



Alphabetical search

1. Press   when the handset is not in use.
-OR-
Press **MENU/SELECT** when the handset is not in use. Press  or  to select **>DIRECTORY** and then press **MENU/SELECT** twice.
2. Use the dialing keys to enter the letters associated with the name. For example, if you have name entries Jenny, Kristen and Linda in your directory, press 5 (**JKL**) once to find Jenny, twice to find Kristen, or three times to find Linda. If there is no name entry matching your search, the next closest match in alphabetical order appears. If necessary, press  or  to browse.

Dial a directory entry

1. Search for the desired entry in the directory (see **Review the directory or Alphabetical search** above).
2. When the desired entry displays, press  /FLASH or  to dial.

Edit a directory entry

1. Search for the desired entry in the directory (see **Review the directory or Alphabetical search** above).
2. Follow Step 2 to Step 6 in **Create a new directory entry** on page 28.

Delete a directory entry

1. Search for the desired entry in the directory (see **Review the directory or Alphabetical search** above).
2. When the desired entry displays, press **MUTE/DELETE**. Then the handset displays **DELETE CONTACT?**
3. Press **MENU/SELECT** to delete the displayed entry. The handset shows **DELETING...** and then **CONTACT DELETED** with a confirmation tone. Once deleted, you cannot retrieve that entry.

Directory

Speed dial

You can copy up to 10 directory entries into the speed dial locations so that you can dial these numbers using fewer keys than usual.

The speed dial memory locations are stored in the telephone base and are shared by all handsets. Changes made to the speed dial entries on one handset apply to all.

Store a speed dial entry

1. Press **MENU/SELECT** when the handset is not in use.
2. Press **▼** or **▲** to scroll to **>DIRECTORY**, then press **MENU/SELECT**.
3. Press **▼** or **▲** to scroll to **>SPEED DIAL**, then press **MENU/SELECT**.
4. Press **▼** or **▲** to choose the desired speed dial location.
5. Press **MENU/SELECT** to show the directory.
6. Press **▼** or **▲** to browse to desired entry.

-OR-

Use the alphabetical search to find the desired entry .

7. Press **MENU/SELECT** to save. The name (up to 12 characters) appears in the selected speed dial location.

note

- If the directory is empty, when you press **MENU/SELECT** in Step 5, the screen shows **DIRECTORY EMPTY**.
- If the speed dial location you selected is occupied, the new directory entry you selected replaces the old one. Take caution not to replace entries you do not wish to delete from the speed dial locations.

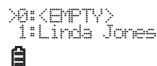

>0:<EMPTY>
1:Linda Jones
📞



COPY FROM
DIRECTORY
📞



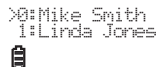

Mike Smith
800-595-9511
📞



>0:Mike Smith
1:Linda Jones
📞

Directory

Dial a speed dial number

1. Press and hold a dialing key (**0** through **9**) to display the desired speed dial when the handset is not in use.
2. Press /FLASH or  to dial the displayed telephone number. When the speed dial location is empty, the screen shows the speed dial list. See **Store a speed dial entry** on page 30 to add a new entry.

Delete a speed dial entry

1. Press **MENU/SELECT** when the handset is not in use.
2. Press **▼** or **▲** to scroll to select **>DIRECTORY**, then press **MENU/SELECT**.
3. Press **▼** or **▲** to select **>SPEED DIAL**, then press **MENU/SELECT**.
4. Press **▼** or **▲** to choose the desired speed dial location, then press **MUTE/DELETE**. **<EMPTY>** appears and you hear a confirmation tone.

note

Deleting the speed dial entries does not affect the entries in the directory.

Caller ID

About caller ID

This product supports caller ID service offered by most telephone service providers. Caller ID allows you to see the name, number, date and time of calls. The available caller ID information will appear after the first or second ring.

Information about caller ID with call waiting

Caller ID with call waiting lets you see the name and telephone number of the caller before answering the call, even while on another call.

It may be necessary to change your telephone service to use this feature. Contact your telephone service provider if:

- You have both caller ID and call waiting, but as separate services (you may need to combine these service).
- You have only caller ID service, or only call waiting service.
- You do not subscribe to caller ID or call waiting service.

There may be fees for caller ID services. In addition, services may not be available in all areas.

This product can provide information only if both you and the caller are in areas offering caller ID service and if both telephone service provider use compatible equipment. The time and date are sent by the telephone service provider along with the call information.

The caller ID information may not be available for every incoming call. The callers may intentionally block their names and /or telephone numbers.

note

You can use this product with regular caller ID service, or you can use this product's other features without subscribing to either caller ID or combined caller ID with call waiting service.

Caller ID

Call log

If you subscribe to caller ID service, information about each caller will appear after the first or second ring. If you answer a call before the caller information appear on the screen, it will not be saved in the call log.

- The call log stores up to 50 entries. Each entry has up to 24 digits for the phone number and 15 characters for the name. If the phone number has more than 15 digits, only the last 15 digits appear. If the name has more than 15 characters, only the first 15 characters are shown and saved in the call log.
- Call log entries are shared by all system handsets. Any modifications made on one handset apply to all.
- You can review, redial, and copy an entry into the directory.
- Entries appear in reverse chronological order.
- When the call log is full, the oldest entry is deleted to make room for new incoming call information.
- **XX MISSED CALLS** shows when there are new call log entries that have not been reviewed.
- **CALL LOG EMPTY** shows when you access the call log without records.
- Only one handset can review the call log at a time. If a handset tries to enter the call log while another handset is already in it, its screen displays **NOT AVAILABLE AT THIS TIME**.

note

- For call log entries with numbers between 16 and 24 digits, in order to view the entire number, you must save the entry to the directory (see page 35).
- If the phone number has more than 24 digits, it will not be saved or shown in the call log.

Caller ID

Missed call indicator

When there are calls that have not been reviewed, the idle handset shows **XX MISSED CALLS**.

Each time you review a call log entry marked **NEW**, the number of missed calls decrease by one.

When you have reviewed all the missed calls, the missed calls indicator no longer shows.

If you do not want to review the missed calls one by one, press and hold OFF/CANCEL on an idle handset to erase the missed call indicator. All entries are then considered old and kept in the call log.

Memory match



When the incoming telephone number matches the last seven digits of a telephone number in your directory, the screen displays the stored name of the directory entry.

For example, if Linda Jones calls, her name appears as **Linda** if this is how you entered into your directory.

note

The number shown in the call log is in the format sent by the telephone service provider. The telephone service provider usually delivers ten-digit telephone numbers (area code plus telephone number). If the last seven digits of the incoming telephone number does not match a number in your directory, the name appears as it is delivered by the telephone service provider.

Review and dial from the call log

1. When a handset is in idle mode, press **CID**▼ to review the call log in reverse chronological order.
-OR-
Press **MENU/SELECT**. Press ▼ or ▲ to scroll to **>CALL LOG**, then press **MENU/SELECT** twice.
2. Press ▼ or ▲ to browse.
3. Press /FLASH or  to dial the displayed telephone number from the call log.



Caller ID

View dialing options

Although the call log entries received have 10 digits (the area code plus the seven-digit number), in some areas, you may dial only the seven digits, or 1 plus the seven digits, or 1 plus the area code plus the seven digits. You may change the number of digits that you dial from or store in the directory.

While reviewing the call log, press # (pound key) repeatedly to show different dialing options for local and long distance numbers before dialing or saving the telephone number in the directory.

Press 1 repeatedly if you need to add or remove 1 in front of the telephone number before dialing or saving it in the directory.

When the number is shown in the correct format for dialing, press /FLASH or  on the handset to dial the displayed number.

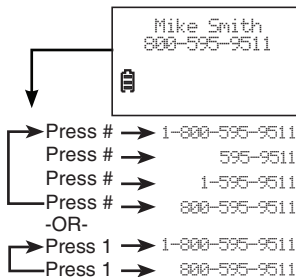

note

If you do not need to dial the area code for local calls, make sure to program your home area code (see page 17).

Save a call log entry to the directory

1. Select a desired entry in the call log (see **Review and dial from the call log** on page 34).
2. Follow Step 2 to Step 6 in **Create a new directory entry** on page 28.

note

If the telephone number has more than 15 digits, only the last 15 digits appear in the call log. The telephone can still save all digits (up to 24 digits) of that call log entry in the directory.

Caller ID

Delete from the call log

To delete one entry:

1. When in the call log, press ▼ or ▲ to browse.
2. Press **MUTE/DELETE** to delete the selected entry. The screen displays **DELETING...** and then you hear a confirmation tone.

To delete all entries:

1. Press **MENU/SELECT** when the handset is not in use.
2. Press ▼ or ▲ to select **>CALL LOG**, then press **MENU/SELECT**.
3. Press ▼ or ▲ to select **>DEL ALL CALLS**, then press **MENU/SELECT**. The screen shows **DELETE ALL CALLS?**
4. Press **MENU/SELECT** to save. The screen shows **DELETING...** and then you hear a confirmation tone.

Call log display screen messages

Displays:	When:
PRIVATE NAME	The caller is blocking the name information.
PRIVATE NUMBER	The caller is blocking the telephone number.
PRIVATE CALLER	The caller is blocking the name and telephone number.
UNKNOWN NAME	The caller's name is unavailable.
UNKNOWN NUMBER	The caller's telephone number is unavailable.
UNKNOWN CALLER	No call information is available about this caller.
LONG DISTANCE -OR- L (before the caller's number)	It is a long distance call.

Answering system settings

Answering system setup

Use the answering system menu of a system handset to turn on or off the answering system or message alert tone, set up the announcement message, activate the call screening, or change the number of rings, remote access code and message recording time.

note

You can turn the answering system on or off from either the handset or the telephone base, but you can only use the handset to change other answering system settings.

Answer on/off

The answering system must be turned on to answer and record messages.

When the answering system is turned on, the  **ANS ON/OFF** light on the telephone base turns on and **ANS ON** displays on the handset.

To turn on or off with the telephone base:

Press  **ANS ON/OFF** to turn the built-in answering system on or off. When the answering system is turned on, it announces, “Calls will be answered.” When the answering system is turned off, it announces, “Calls will not be answered.”

To turn on or off with the handset:

1. Press **MENU/SELECT** when the handset is not in use.
2. Press **▼** or **▲** to select **>ANSWERING SYS**, then press **MENU/SELECT**.
3. Press **▼** or **▲** to select **>ANSWER ON/OFF**, then press **MENU/SELECT**.
4. Press **▼** or **▲** to choose **ON** or **OFF**, then press **MENU/SELECT** to save. You hear a confirmation tone.

note

You cannot turn the answering system on or off while a handset is on a call or the telephone base is playing messages.

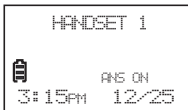
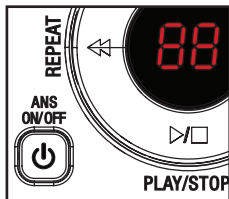

Announcement

The telephone is preset with a greeting that answers calls with “Hello, please leave a message after the tone.” You can use this preset announcement, or replace it with your own.

Answering system settings

Record a new announcement

1. Press **MENU/SELECT** when the handset is not in use.
2. Press **▼** or **▲** to scroll to **>ANSWERING SYS**, then press **MENU/SELECT**.
3. Press **MENU/SELECT** to choose **>ANNOUNCEMENT**. The system announces, *"To play, press 2. To record, press 7."*
4. Press **7**. The system announces, *"Record after the tone. Press 5 when you are done."*
5. After the tone, face and speak towards the handset microphone to record your announcement.
6. Press **5** when you finish the recording. The handset plays back the recorded announcement.

note

Your announcement can be up to 90 seconds in length. The system does not record any announcement shorter than two seconds.

Play the announcement

1. Press **MENU/SELECT** when the handset is not in use.
2. Press **▼** or **▲** to scroll to **>ANSWERING SYS**, then press **MENU/SELECT**.
3. Press **MENU/SELECT** to choose **>ANNOUNCEMENT**. The system announces, *"To play, press 2. To record, press 7."*
4. Press **2** to play the current announcement from the speakerphone.
 - Press **▼/VOLUME** to decrease or **▲/VOLUME** to increase the listening volume.
 - Press **📞** to switch between the speakerphone and the handset earpiece.

Delete your announcement

1. Press **MENU/SELECT** when the handset is not in use.
2. Press **▼** or **▲** to select **>ANSWERING SYS**, then press **MENU/SELECT**.
3. Press **MENU/SELECT** to select **>ANNOUNCEMENT**.
4. The handset announces, *"To play, press 2. To record, press 7"* and the screen displays **2-PLAY 3-DELETE 5-STOP 7-RECORD**. Press **3** or **MUTE/DELETE** to delete your own recorded announcement. The handset announces, *"Announcement deleted."*

note

When your announcement is deleted, calls are answered with the default announcement.

Answering system settings

Call screening

You can listen at the telephone base to a caller leaving a message. If you want to turn off the call screening feature, use a system handset to turn this feature off.

1. Press **MENU/SELECT** when the handset is not in use.
2. Press **▼** or **▲** to select **>ANSWERING SYS**, then press **MENU/SELECT**.
3. Press **▼** or **▲** to select **>ANS SYS SETUP**, then press **MENU/SELECT**.
4. Press **MENU/SELECT** to select **>CALL SCREENING**.
5. Press **▼** or **▲** to choose **ON** or **OFF**, then press **MENU/SELECT** to save. You hear a confirmation tone.

Number of rings

You can set the answering system to answer an incoming call after two, three, four, five, six rings; or toll saver. With toll saver selected, the answering system answers a call after two rings if you have new messages, and after four rings when there are no new messages. This feature allows you to check for new messages and avoid paying long distance charges if you are calling from out of your local area.

1. Press **MENU/SELECT** when the handset is not in use.
2. Press **▼** or **▲** to scroll to **>ANSWERING SYS**, then press **MENU/SELECT**.
3. Press **▼** or **▲** to scroll to **>ANS SYS SETUP**, then press **MENU/SELECT**.
4. Press **▼** or **▲** to scroll to **># OF RINGS**, then press **MENU/SELECT**.
5. Press **▼** or **▲** to scroll and choose among **2, 3, 4, 5, 6** or **TOLL SAVER**.
6. Press **MENU/SELECT** to save. You hear a confirmation tone.

Remote access code

A two-digit security code is required to access the answering system remotely from any touch-tone telephone. The default code is **19**. You can set the code from **00** to **99**.

1. Press **MENU/SELECT** when the handset is not in use.
2. Press **▼** or **▲** to select **>ANSWERING SYS**, then press **MENU/SELECT**.
3. Press **▼** or **▲** to select **>ANS SYS SETUP**, then press **MENU/SELECT**.
4. Press **▼** or **▲** to select **>REMOTE CODE**, then press **MENU/SELECT**.
5. Press the dialing keys (**0-9**) to enter the code or **▼** or **▲** to select from **00** to **99**, then press **MENU/SELECT** to save your selection. You hear a confirmation tone.

Answering system settings

Message alert tone

When the message alert tone is turned on and you have new message(s), the telephone base beeps every 10 seconds. Unless you change it, the message alert tone is set to off.

1. Press **MENU/SELECT** when the handset is not in use.
2. Press ▼ or ▲ to select **>ANSWERING SYS**, then press **MENU/SELECT**.
3. Press ▼ or ▲ to select **>ANS SYS SETUP**, then press **MENU/SELECT**.
4. Press ▼ or ▲ to select **>MSG ALERT TONE**, then press **MENU/SELECT**.
5. Press ▼ or ▲ to choose **ON** or **OFF**, then press **MENU/SELECT** to save your selection. You hear a confirmation tone.

note

- The answering system must be turned on for the message alert tone to function.
- Press any key on the telephone base (except /FIND HANDSET) to temporarily silence the message alert tone.

Recording time



You can set the recording time for each incoming message.

1. Press **MENU/SELECT** when the handset is not in use.
2. Press ▼ or ▲ to select **>ANSWERING SYS**, then press **MENU/SELECT**.
3. Press ▼ or ▲ to select **>ANS SYS SETUP**, then press **MENU/SELECT**.
4. Press ▼ or ▲ to select **>RECORDING TIME**, then press **MENU/SELECT**.
5. Press ▼ or ▲ to choose from **3 MINUTES**, **2 MINUTES** or **1 MINUTE**, then press **MENU/SELECT** to save. You hear a confirmation tone.

Answering system operation

Answering system and voicemail indicators

Your telephone has separate indicators for two different types of voice messages: those left on its built-in answering system and those left at your service provider's (fees may apply). Your telephone's built-in answering system messages and voicemail messages are separate. Each alerts you to new messages differently.

- If **XX NEW MESSAGES** and  display on the handset and the message window on the telephone base flashes, there are new messages recorded on the built-in answering system. Press **MENU/SELECT** twice on the handset (page 44) or **▶/■/PLAY/STOP** on the telephone base (page 44) to listen.
- If **NEW VOICEMAIL** and  display on the handset, your telephone service provider is indicating that it has new voicemail for you. To listen to your voicemail, you typically dial an access number provided by your telephone service provider, followed by security code or PIN.

Some service providers bundle or combine multiple services like voicemail and call waiting, so you may not be aware that you have voicemail. To check what services you have and how to access them, contact your telephone service provider.

To use your voicemail service rather than your answering system, turn off your answering system. To use your answering system rather than your voicemail service, contact your telephone service provider to deactivate your voicemail service.

Using the answering machine and voicemail together

You can also use your telephone answering system and voicemail together by setting your built-in answering system to answer before voicemail answers as described below. To learn how to program your voicemail settings, contact your telephone service provider. Then, if you are on a call, or if the answering system is busy recording a message and you receive another call, the second caller can leave a voicemail message.

Set your answering system to answer calls at least two rings earlier than your voicemail is set to answer. For example, if your voicemail answers after six rings, set your answering system to answer after four rings. Some voicemail providers may program the delay before answering calls in seconds instead of rings. In this case, allow six seconds per ring when determining the appropriate setting.

Answering system operation

Voice prompts

The system provides voice prompts to guide you through recording announcement and remote access.

Message capacity

The answering system can record up to 99 messages, depending on the length of each message. Individual messages can be up to three minutes see page 40 to change the length. The total recording time for the announcement, messages and memos is approximately 14 minutes. The actual recording time depends on individual message characteristics. Messages remain available for replay until you delete them.

If the memory is full, the answering system announces, “*Memory is full.*” The number of messages and **F** flash alternately in the message window, and **REC MEM FULL** appears on the handset. You must delete some messages before recording new ones.

Answering system new message indication

When there are new message (including memos), **XX NEW MESSAGES** and **oo** display on handset, and the message window on the telephone base flashes. When you are reviewing a new message, **oo** displays on the handset.

If the message alert tone is turned on, the telephone base beeps every 10 seconds when there are new messages.



Call screening at the telephone base

If the answering system and call screening are on (see **Call screening** on page 39), the announcement and the incoming message broadcast at the telephone base when a call is answered by the answering system.

Options while recording a message:

- Press **▲/VOL+** or **▼/VOL-** on the telephone base to adjust the call screening volume.
- Press **▶/■/PLAY/STOP** to temporarily turn on or off call screening.
- Press **▲/VOL+** to temporarily turn on call screening when it is set to off.

Answering system operation

Call screening at the handset

If the answering system is on, the announcement and the incoming message broadcast at the telephone base when a call is answered by the answering system. At the same time, the handset shows **TO SCREEN CALL, PRESS [SELECT]**. Press **MENU/SELECT** to screen the call on your handset. The handset shows the caller's information. If you do not subscribe to caller ID service, the handset shows **SCREENING...**

note

Call screening setting has no effect on the call screening at the handset.

Call intercept

While call screening, you can press /FLASH or  on the handset to stop recording and speak to the caller.

Message playback

You can use either a handset or the telephone base to play messages. If there are new messages, the system plays back only the new messages (oldest first). If there are no new messages, the system plays back all old messages (oldest first).

When playback begins, the total number of messages is announced. Before each message playback, you hear the day and time it was received. After the last message is played, you hear *"End of messages."*

note

- Only one handset or the telephone base can access the answering system at a time.
- During message playback, if there is an incoming call or another handset makes a call, message playback will be stopped.

Answering system operation

Message playback (continued)

To play messages with the telephone base:

Press ►/■/PLAY/STOP when the telephone is not in use.

Options during playback:

- Press ▲/VOL+ or ▼/VOL- to adjust the speaker volume.
- Press ►/SKIP to skip to the next message.
- Press ◀/REPEAT to repeat the message currently playing. Press ◀/REPEAT twice to listen to the previous message.
- Press X/DELETE to delete the current message. The system advances to the next message.
- Press ►/■/PLAY/STOP to stop.

note

When there are no messages in the answering system, the handset shows **NO MESSAGE** and announces, “*You have no message.*”

To play messages with a handset:

Press **MENU/SELECT** twice when the telephone is not in use.

The screen displays **3-DELETE 5-STOP 4-REPEAT 6-SKIP** and the handset announces the total number of messages.

Options during playback:

- Press ▼/VOLUME to decrease or ▲/VOLUME to increase the message playback volume.
- Press ◀/▶ to switch between the speakerphone and the handset.
- Press **3** or **MUTE/DELETE** to delete the message. The handset announces, “*Message deleted.*”
- Press **5** to stop the playback.
- Press **4** to repeat the message currently playing. Press **4** twice to listen to the previous message.
- Press **6** to skip to the next message.



Answering system operation

Delete all old messages

To delete all old messages with the telephone base:

1. Press **X/DELETE** on the telephone base. The system announces, *“To delete all old messages, press **DELETE** again.”*
2. Press **X/DELETE** within three seconds. The system announces, *“All old messages deleted.”*

To delete all old messages with a handset:

1. Press **MENU/SELECT** when the handset is not in use.
2. Press ▼ or ▲ to scroll to **>ANSWERING SYS**, then press **MENU/SELECT**.
3. Press ▼ or ▲ to scroll to **>DELETE ALL OLD**.
4. Press **MENU/SELECT**. The screen shows **DELETE ALL OLD MESSAGES?**
5. Press **MENU/SELECT**. The screen shows **DELETING...** and then **ALL OLD MSGS DELETED!** with a confirmation tone.

note

- If there are no old messages and you press **X/DELETE** twice on the telephone base, the system announces, *“You have no old message.”* On the handset, when you select **DELETE ALL OLD**, the screen shows **NO MESSAGE**.
- Only old messages can be deleted.

Answering system operation

Record, play or delete memos

Memos are messages you record yourself. They are saved, played back and deleted exactly like incoming messages. You can record a memo as a reminder to yourself, or leave a message for someone else using the same telephone.

1. Press **MENU/SELECT** when the handset is not in use.
2. Press ▼ or ▲ to scroll to **>ANSWERING SYS**, then press **MENU/SELECT**.
3. Press ▼ or ▲ to scroll to **>RECORD MEMO**.
4. Press **MENU/SELECT**. The system announces, *“Record after the tone. Press 5 when you are done.”*
5. Speak towards the handset microphone after a long beep. You can record a memo up to three minutes. Memos shorter than two seconds are not recorded.
6. Press **5** to stop recording. The system announces, *“Recorded.”*

note

- If you record a memo when the answering system memory is full, *“Memory is full”* will be announced.
- When the answering system has less than three minutes of recording time left, *“Less than three minutes to record,”* is announced at the telephone base and the handset displays **REC MEM LOW**.

Answering system operation

Message window displays

The message window on the telephone base displays the total number of messages. See the table below for other message window displays.

Window display	Description
0	No messages.
1-99	The total number of old messages recorded. The current message number during old message playback.
0-99 (flashing)	When time and date are not set, it flashes the total number of new messages recorded, or the total number of old messages recorded. The telephone base may have lost and regained power. The clock needs to be set.
1-99 & F (alternating)	The answering system memory is full with total number of messages recorded.
1-8	The telephone base speaker volume level while adjusting.
0-6	The telephone base ringer level while adjusting.
- -	The answering system is being programmed by a system handset. The answering system is answering a call, or recording a memo or announcement. The answering system is being accessed remotely.

note

When the memory is full, the answering system answers incoming calls after 10 rings and announces, *"Memory is full. Enter your remote access code."*

Answering system operation

Remote access

A two-digit security code is required to access the answering system remotely from any touch-tone telephone. The preset code is **19**; see **Remote access code** on page 39 to change it.

To remotely access the answering system:

1. Dial your telephone number from any touch-tone telephone.
2. When the answering system answers, enter the two-digit remote access code.
3. Then you can enter one of the following remote commands.

Command	Function
1	Play all messages.
2	Play new messages.
3	Delete a message (during playback).
33	Delete all old messages.
4	Repeat the current message (during playback).
5	Stop.
*5	Hear a list of remote commands.
6	Skip to the next message (during playback).
*7	Record an announcement.
8	End the call.
0	Turn the answering system on or off.

4. Hang up or press **8** to end the call.

note

- If you do not press any keys after you enter the remote access code, all new messages play. If there are no new messages, all old messages play.
- Once the new messages have played, the telephone announces the help menu options. If you do not press any key within 20 seconds, the remote access call automatically disconnects.
- When the answering system is turned off, the telephone answers after 10 rings, and announces, *"Please enter your remote access code."*

Appendix

Handset display screen messages

CALL LOG EMPTY	There are no call log entries.
CALLING HANDSET X (for models with three or more handsets) CALLING OTHER HANDSET (for models with two handsets)	You are calling another handset.
CALL TRANSFERRED	You have transferred an outside call to another cordless handset.
DIRECTORY EMPTY	There are no directory entries.
DIRECTORY FULL	The directory is full. You cannot save any new entries unless you delete some current entries.
ENDED	You have just ended a call.
HANDSET X IS CALLING (for models with three or more handsets) OTHER HANDSET IS CALLING (for models with two handsets)	Another handset is calling.
INCOMING CALL	There is a call coming in.
INTERCOM	The handset is on an intercom call.
INTERCOM ENDED	The intercom call has just ended.
INTERCOM TO:	You have started the intercom process, and need to enter the number of the handset you wish to call. You have started transferring a call, and need to enter the desired handset number.
LINE IN USE	An extension telephone on the same line or one of the handset is in use.
LOW BATTERY	The battery needs to be charged.
MICROPHONE ON	Mute is off so the other party can hear your voice.
MUTED	The microphone is off.

Appendix

Handset display screen messages

NUMBER ALREADY SAVED	The telephone number you have entered is already stored in the directory.
NEW VOICEMAIL	There are new voicemail messages from your telephone service provider.
NO BATTERY	You place the handset in the telephone base or charger without installing a battery in that handset.
NO LINE	There is no telephone line connected.
NO MESSAGE	There are no messages in the answering system.
NOT AVAILABLE AT THIS TIME	Someone else is already using the directory, speed dial list, call log or answering system.
OUT OF RANGE OR NO PWR AT BASE	The handset has lost communication with the telephone base.
PAGING	The telephone base is paging all handsets.
PHONE	The handset is on a call.
PLACE IN CHARGER	The battery is very low. The handset should be placed in the telephone base or charger for charging.
REC MEM FULL	The answering system memory is full.
REC MEM LOW	The answering system has less than three minutes of recording time left.
RINGER MUTED	The ringer is muted temporarily during an incoming call.
SAVED	The entry has been saved in the directory.
SPEAKER	The handset speakerphone is in use.
UNABLE TO CALL, TRY AGAIN	Failed intercom or two handsets are already on a call. Communication between the handset and the telephone base is lost during a call.
XX MISSED CALLS	There are XX new calls in the caller ID history.
XX NEW MESSAGES	There are XX new messages in the answering system.

Appendix

Handset and telephone base indicators







Handset lights

	On when the handset speakerphone is in use.
CHARGE	On when the handset is charging in the telephone base or charger.

Telephone base lights

IN USE	On when the telephone line is in use. On when the answering system is answering a call. On when you are registering a handset. Flashes quickly when there is an incoming call. Flashes when another telephone sharing the same line is in use. Flashes when you are deregistering all handsets.
 ANS ON/OFF	On when the answering system is turned on.

Handset icons

	Battery status - flashes when the battery is low and needs charging.
	Battery status - animates when the battery is charging.
	The speakerphone is in use.
	The handset ringer is turned off.
	New voicemail - indicates you have received new voicemail message(s) from the telephone service provider.
ANS ON	The answering system is turned on.
OO	There are new answering system messages.
NEW	New call log entries - indicates you have new missed call(s) in the call log.
MUTE	The microphone is muted.
	The message number currently playing and total number of messages recorded.

Appendix

Expand your telephone system

You can add new handsets (**CS6409**, purchased separately) to your telephone base. Your telephone base supports a maximum of 5 handsets.

For more details, refer to the user's manual that comes with your **CS6409** new handset.

Appendix

Troubleshooting

If you have difficulty with your telephone, please try the suggestions below. For customer service, visit our website www.vtechphones.com, or call 1(800) 595-9511. In Canada, go to www.vtechcanada.com, or call 1 (800) 267-7377.

My telephone does not work at all.

- Make sure the battery is installed and charged correctly (pages 3-5). For optimum daily performance, return the handset to the telephone base or charger after use.
- Make sure that the power adapter is securely plugged into an outlet not controlled by a wall switch.
- Make sure the telephone line cord is plugged firmly into the telephone base and the telephone wall jack.
- Unplug the electrical power to the telephone base. Wait for approximately 15 seconds, then plug it back in. Allow up to one minute for the cordless handset and telephone base to synchronize.
- Charge the battery in the handset for up to 10 hours.
- If the battery is completely depleted, it may take up to 30 minutes to charge the handset before **LOW BATTERY** appears on the screen (page5).
- Remove and install the battery again. If that still does not work, it may be necessary to purchase a new battery.
- Disconnect the telephone base from the telephone wall jack and plug in a working telephone. If the other telephone does not work, the problem is probably in the wiring or the local telephone service. Contact your telephone service provider.

The display shows **NO LINE**. I cannot get a dial tone.

- Try all the above suggestions.
- Make sure the telephone line cord is plugged firmly into the telephone base and the telephone wall jack.
- Disconnect the telephone line cord from your telephone and connect it to another telephone. If there is no dial tone on that other telephone either, then the telephone line cord may be defective. Try installing a new telephone line cord. If changing the telephone line cord does not help, the wall jack (or the wiring to this wall jack) may be defective. Contact your telephone service provider.

Appendix

Troubleshooting

The display shows 1.PRESS FIND HS ON BASE 4 SEC and 2.THEN PRESS # ON HANDSET alternately. The handset does not work at all.

- The handset is deregistered from the telephone base. To register it back:
 1. Press and hold /FIND HANDSET on the telephone base for about four seconds until the red **IN USE** light on the telephone base turns on.
 2. Press # (pound key) on the handset. The handset shows **REGISTERING..... PLEASE WAIT**. The handset shows **HANDSET REGISTERED** and you hear a beep when the registration process completes. This process takes about 60 seconds.

If the registration fails, the handset shows **REGISTRATION FAILED** and then **1.PRESS FIND HS ON BASE 4 SEC** and **2.THEN PRESS # ON HANDSET** alternately. Remove the handset from the telephone base and place it back in. Repeat Steps 1 and 2 again.

I cannot dial out.

- Try all the above suggestions.
- Make sure there is a dial tone before dialing. It is normal if the handset takes a second or two to synchronize with the telephone before producing a dial tone. Wait an extra second before dialing.
- If other telephones in your home are having the same problem, the problem is in the wiring or local telephone service. Contact your telephone service provider (charges may apply).
- Eliminate any background noise. Mute the cordless handset before dialing, or dial from another room in your home with less background noise.

LOW BATTERY shows on the handset screen.

- Place the handset in the telephone base or charger for recharging.
- Remove and install the battery again and use it until fully depleted, then charge the handset in the telephone base or charger for up to 10 hours.
- If the above measures do not correct the problem, replace the battery.

The battery does not charge in the handset or the handset battery does not accept charge.

- Make sure the handset is placed in the telephone base or charger correctly. The **CHARGE** light on the handset should be on.
- Remove and install the battery again, then charge for up to 10 hours.
- If the handset is in the telephone base or charger but **CHARGE** light on the handset is not on, refer to **The CHARGE light is off** below.
- If the battery is completely depleted, it may take up to 30 minutes to charge the handset before **LOW BATTERY** appears on the screen (page 5).
- Purchase a new battery. Refer to **Battery installation** (page 3).

Appendix

Troubleshooting

The CHARGE light is off.

- Clean the charging contacts on the handset and telephone base each month with a pencil eraser or a dry non-abrasive fabric.
- Make sure the power adapter and telephone line cord are plugged in correctly and securely (page 2).
- Unplug the power adapter. Wait for 15 seconds before plugging it back in. Allow up to one minute for the handset and telephone base to reset.

The telephone does not ring when there is an incoming call.

- Make sure the handset ringer volume is not set to off (page 13) and the telephone base ringer volume is not set to zero (page 12).
- Make sure the telephone line cord and power adapter are plugged in properly (page 2).
- The handset may be too far from the telephone base. Move it closer to the telephone base.
- There may be too many extension phones on the telephone line to allow all of them to ring simultaneously. Unplug some of them.
- If other telephones in your home are having the same problem, the problem is in the wiring or local service. Contact your telephone service provider.
- Other electronic products such as HAM radios and other DECT phones can cause interference with your cordless phone. Try installing your phone as far away as possible from these types of electronic devices.
- Test a working telephone at the telephone wall jack. If another telephone has the same problem, the problem is in the telephone wall jack. Contact your telephone service provider.
- The telephone line cord may be defective. Install a new telephone line cord.
- Remove and install the battery again, and place the handset in the telephone base or charger.
- Wait for the handset to synchronize with the telephone base. Allow up to one minute for this to take place.

My handset beeps and is not performing normally.

- Make sure the power cord is securely plugged into the telephone base. Plug the telephone base into a different working electrical outlet not controlled by a wall switch.
- Move the handset closer to the telephone base. It may be out of range.
- Reset the telephone base by unplugging the electrical power to the base. Wait for 15 seconds and plug it back in again. Allow up to one minute for the cordless handset and telephone base to synchronize.

Appendix

Troubleshooting

- Other electronic products such as HAM radios and other DECT phones can cause interference with your cordless phone. Try installing your phone as far away as possible from these types of electronic devices.

There is interference during a telephone conversation. My calls fade out when I am using the cordless handset.

- The handset may be out of range. Move it closer to the telephone base.
- If you subscribe to high-speed Internet service (DSL - digital subscriber line) through your telephone line, you must install a DSL filter between the telephone line cord and the telephone wall jack. The filter prevents noise and caller ID problems caused by DSL interference. Contact your DSL service provider for more information about DSL filters.
- Appliances or other cordless telephones plugged into the same circuit as the telephone base can cause interference. Try moving the appliance or telephone base to another outlet.
- Other electronic products such as HAM radios and other DECT phones can cause interference with your cordless phone. Try installing your phone as far away as possible from these types of electronic devices.
- If your telephone is plugged in with modem or a surge protector, plug the telephone (or modem/surge protector) into a different location. If this does not solve the problem, relocate your telephone or modem farther apart from each other, or use a different surge protector.
- The location of your telephone base can impact the performance of your cordless phone. For better reception, install the telephone base in a centralized location within your home or office, away from walls or other obstructions. In many environments, elevating the telephone base improves overall performance.
- Disconnect the telephone base from the telephone wall jack and plug in a corded telephone. If calls are still not clear, the problem is probably in the wiring or local service. Contact your telephone service provider (charges may apply).
- If other telephones in your home are having the same problem, the problem is in the wiring or local telephone service. Contact your telephone service provider (charges may apply).

I hear other calls when using the telephone.

- Disconnect the telephone base from the telephone wall jack. Plug in a different telephone. If you still hear other calls, the problem is probably in the wiring or local service. Contact your telephone service provider.

Appendix

Troubleshooting

I hear noise on the cordless handset and the keys do not work.

- Make sure the telephone line cord is plugged in securely.

My caller ID features are not working properly.

- Caller ID is a subscription service. You must subscribe to this service from your telephone service provider for this feature to work on your telephone.
- The caller may not be calling from an area which supports caller ID.
- Both your and your caller's telephone service providers must use equipment compatible with the caller ID service.
- The caller ID information shows after the first or second ring.
- If you subscribe to high-speed Internet service (DSL - digital subscribe line) through your telephone line, you must install a DSL filter between the telephone line cord and the telephone wall jack. The filter prevents noise and caller ID problems caused by DSL interference. Contact your DSL service provider for more informaton about DSL filters.

The telephone does not receive caller ID or the telephone does not show caller ID during call waiting.

- Make sure you subscribe to caller ID with call waiting features provided by your telephone service provider.
- The caller may not be calling from an area which supports caller ID.
- Both your and your caller's telephone service providers must use equipment compatible with caller ID service.
- If you subscribe to high-speed Internet service (DSL - digital subscribe line) through your telephone line, you must install a DSL filter between the telephone line cord and the telephone wall jack. The filter prevents noise and caller ID problems caused by DSL interference. Contact your DSL service provider for more informaton about DSL filters.

Caller ID entries do not match the numbers I need to dial.

- Caller ID service delivers 10 digits (the area code plus the seven -digits number). If you need to dial something other than 10 digits, see **View dialing options** on page 35.
- If you dial seven digits for local calls, you may want to use the home area code feature (page 17).

Appendix

Troubleshooting

OUT OF RANGE OR NO PWR AT BASE shows in the handset screen.

- The handset may be out of range. Move it closer to the telephone base.
- Make sure the power cord is securely plugged into the telephone base. Use a working electrical outlet not controlled by a wall switch.
- Reset your telephone by unplugging the power adapter from the telephone base. Disconnect the battery from the cordless handset. Wait for 15 seconds, then plug in the power adapter and reinstall the battery. Place the handset in the telephone base and allow up to one minute for the handset and telephone base to synchronize.
- Other electronic products such as HAM radios and other DECT phones can cause interference with your cordless phone. Try installing your phone as far away as possible from these types of electronic devices.

NEW VOICEMAIL and show on the display and I don't know why.

- Your telephone has voicemail indication that is separate from the built-in answering system. If **NEW VOICEMAIL** and  appear on the display, then your telephone has received a signal from your telephone service provider that you have a voicemail message waiting for you to retrieve from your telephone service provider. Contact your telephone service provider for more information on how to access your voicemail.

I cannot retrieve voicemail messages.

- Your telephone has both a built-in answering system and voicemail indication. They are independent features and each alerts you to new messages differently (see **Answering system new message indication** on page 42). If you subscribe to voicemail service from your telephone service provider (charges may apply), contact your telephone service provider for more information on how to access your voicemail.

The answering system does not answer after correct number of rings.

- Make sure the answering system is on. When the answering system is on, **ANS ON** should show on the handset and the  **ANSWER ON/OFF** light is lit on the telephone base (see **Answer on/off** on page 37).
- If toll saver is selected, the number of rings changes to two when there are new messages (see **Number of rings** on page 39).
- If the memory is full or the answering system is off, the answering system answers after 10 rings. In some cases, the answering system is affected by the ringing system used by the telephone service provider.

Appendix

Troubleshooting

- If you subscribe to voicemail service, change the number of rings so that your answering system answers before your voicemail answers (see **Answering system new message indication** on page 42). To get help with your voicemail settings, contact your telephone service provider.
- If there is a fax machine connected to the same telephone line, try disconnecting the fax machine. If that solves the problem, consult your fax machine documentation for information on compatibility with answering systems.

The outgoing announcement is not clear.

- When recording the announcement, make sure you speak in a normal tone of voice towards the microphone of the handset.
- Make sure there is no background noise when recording.

The answering system does not record messages.

- Make sure the answering system is on (see **Answer on/off** on page 37).
- Make sure the memory of the answering system is not full. When the answering machine memory is full, it does not record new messages until some old messages are deleted.
- If you subscribe to voicemail service, change the number of ring so that your answering system answers before your voicemail answers (see **Answering system new message indication** on page 42). To determine how many rings activate your voicemail, contact your telephone service provider.
- If there is a fax machine connected to the same telephone line, try disconnecting the fax machine. If that solves the problem, consult your fax machine documentation for information on compatibility with answering systems.

The messages on the answering system are very difficult to hear.

- Press ▲/VOL+ on the telephone base or ▲/VOLUME on the handset to increase the speaker volume.

The messages on the answering system are incomplete.

- If a caller leaves a very long message, part of it may be lost when the answering system disconnects the call after the preset recording time.
- If the memory on the answering system becomes full during a message, the answering system stops recording and disconnects the call.
- If the caller's voice is very soft, the answering system may stop recording and disconnect the call.

Appendix

Troubleshooting

The answering system does not respond to remote commands.

- Make sure to enter your remote access code correctly (see **Remote access code** on page 39).
- Make sure you are calling from a touch-tone telephone. When you dial a number, you should hear tones. If you hear clicks, the telephone is not a touch-tone telephone and cannot activate the answering system.
- The answering system may not detect the remote access code while your announcement is playing. Try waiting until the announcement is over before entering the code.
- There may be interference on the telephone line you are using. Press the dialing keys firmly.

I subscribe to a nontraditional telephone service that uses my computer to establish connections, and my telephone doesn't work.

- Make sure your computer is powered on.
- Make sure your Internet connection is working properly.
- Make sure that the software is installed and running for your nontraditional telephone service.
- Make sure to plug your USB telephone adapter into a dedicated USB port on your computer. Do not plug into a multiple port USB hub (USB splitter) that is not powered.
- In a few rare instances, the USB port on your computer may not have enough power. In these instances, try using a USB hub with its own external power supply.
- If you are using a firewall, it may prevent access to your nontraditional telephone service. Contact your service provider for more information.

Common cure for electronic equipment.

If your telephone does not seem to be responding normally, try putting the handset in its base. If this does not fix the problem, do the following (in the order listed):

1. Disconnect the power to the telephone base.
2. Disconnect the cordless handset battery.
3. Wait a few minutes before connecting power to the telephone base.
4. Install the battery again and place the cordless handset in the telephone base or charger.
5. Wait for the cordless handset to synchronize with the telephone base. Allow up to one minute for this to take place.

Appendix

Important safety instructions

When using your telephone equipment, basic safety precautions should always be followed to reduce the risk of fire, electric shock and injury, including the following:

1. Read and understand all instructions.
2. Follow all warnings and instructions marked on the product.
3. Unplug this product from the wall outlet before cleaning. Do not use liquid or aerosol cleaners. Use a damp cloth for cleaning.
4. Do not use this product near water such as near a bath tub, wash bowl, kitchen sink, laundry tub or swimming pool, or in a wet basement or shower.
5. Do not place this product on an unstable table, shelf, stand or other unstable surfaces.
6. Avoid placing the telephone system in places with extreme temperature, direct sunlight, or other electrical devices. Protect your phone from moisture, dust, corrosive liquids and fumes.
7. Slots and openings in the back or bottom of the telephone base and handset are provided for ventilation. To protect them from overheating, these openings must not be blocked by placing the product on a soft surface such as a bed, sofa or rug. This product should never be placed near or over a radiator or heat register. This product should not be placed in any area where proper ventilation is not provided.
8. This product should be operated only from the type of power source indicated on the marking label. If you are not sure of the type of power supply in your home or office, consult your dealer or local power company.
9. Do not allow anything to rest on the power cord. Do not install this product where the cord may be walked on.
10. Never push objects of any kind into this product through the slots in the telephone base or handset because they may touch dangerous voltage points or create a short circuit. Never spill liquid of any kind on the product.
11. To reduce the risk of electric shock, do not disassemble this product, but take it to an authorized service facility. Opening or removing parts of the telephone base or handset other than specified access doors may expose you to dangerous voltages or other risks. Incorrect reassembling can cause electric shock when the product is subsequently used.
12. Do not overload wall outlets and extension cords.
13. Unplug this product from the wall outlet and refer servicing to an authorized service facility under the following conditions:
 - When the power supply cord or plug is damaged or frayed.
 - If liquid has been spilled onto the product.
 - If the product has been exposed to rain or water.
 - If the product does not operate normally by following the operating instructions. Adjust only those controls that are covered by the operation instructions. Improper adjustment of other controls may result in damage and often requires extensive work by an authorized technician to restore the product to normal operation.
 - If the product has been dropped and the telephone base and/or handset has been damaged.
 - If the product exhibits a distinct change in performance.
14. Avoid using a telephone (other than cordless) during an electrical storm. There is a remote risk of electric shock from lightning.
15. Do not use the telephone to report a gas leak in the vicinity of the leak. Under certain circumstances, a spark may be created when the adapter is plugged into the power outlet, or when the handset is replaced in its cradle. This is a common event associated with the closing of any electrical circuit. The user should not plug the phone into a power outlet, and should not put a charged handset into the cradle, if the phone is located in an environment containing concentrations of flammable or flame-supporting gases, unless there is adequate ventilation. A spark in such an environment could create a fire or explosion. Such environments might include: medical use of oxygen without adequate ventilation; industrial gases (cleaning solvents; gasoline vapors; etc.); a leak of natural gas; etc.
16. Only put the handset of your telephone next to your ear when it is in normal talk mode.

Appendix

Important safety instructions

17. The power adapters are intended to be correctly oriented in a vertical or floor mount position. The prongs are not designed to hold the plug in place if it is plugged into a ceiling, under-the-table or cabinet outlet.

SAVE THESE INSTRUCTIONS

Battery

- CAUTION: Use Only Supplied Battery.
- Do not dispose of the battery in a fire. Check with local waste management codes for special disposal instructions.
- Do not open or mutilate the battery. Released electrolyte is corrosive and may cause burns or injury to the eyes or skin. The electrolyte may be toxic if swallowed.
- Exercise care in handling batteries in order not to create a short circuit with conductive materials.
- Charge the battery provided with or identified for use with this product only in accordance with the instructions and limitations specified in this manual.

Precautions for users of implanted cardiac pacemakers

Cardiac pacemakers (applies only to digital cordless telephones):

Wireless Technology Research, LLC (WTR), an independent research entity, led a multidisciplinary evaluation of the interference between portable wireless telephones and implanted cardiac pacemakers. Supported by the U.S. Food and Drug Administration, WTR recommends to physicians that:

Pacemaker patients

- Should keep wireless telephones at least six inches from the pacemaker.
- Should NOT place wireless telephones directly over the pacemaker, such as in a breast pocket, when it is turned ON.
- Should use the wireless telephone at the ear opposite the pacemaker.

WTR's evaluation did not identify any risk to bystanders with pacemakers from other persons using wireless telephones.

About cordless telephones

- **Privacy:** The same features that make a cordless telephone convenient create some limitations. Telephone calls are transmitted between the telephone base and the cordless handset by radio waves, so there is a possibility that the cordless telephone conversations could be intercepted by radio receiving equipment within range of the cordless handset. For this reason, you should not think of cordless telephone conversations as being as private as those on corded telephones.
- **Electrical power:** The telephone base of this cordless telephone must be connected to a working electrical outlet. The electrical outlet should not be controlled by a wall switch. Calls cannot be made from the cordless handset if the telephone base is unplugged, switched off or if the electrical power is interrupted.
- **Potential TV interference:** Some cordless telephones operate at frequencies that may cause interference to televisions and VCRs. To minimize or prevent such interference, do not place the telephone base of the cordless telephone near or on top of a TV or VCR. If interference is experienced, moving the cordless telephone farther away from the TV or VCR often reduces or eliminates the interference.
- **Rechargeable batteries:** Exercise care in handling batteries in order not to create a short circuit with conducting material such as rings, bracelets, and keys. The battery or conductor may overheat and cause harm. Observe proper polarity between the battery and the battery charger.
- **Nickel-metal hydride rechargeable batteries:** Dispose of these batteries in a safe manner. Do not burn or puncture the battery. Like other batteries of this type, if burned or punctured, they could release caustic material which could cause injury.

Appendix

Operating range

This cordless telephone operates with the maximum power allowed by the Federal Communications Commission (FCC). Even so, this handset and telephone base can communicate over only a certain distance - which can vary with the locations of the telephone base and handset, the weather, and the layout of your home or office.

When the handset is out of range, the handset displays **OUT OF RANGE OR NO PWR AT BASE**.

If there is a call while the handset is out of range, it might not ring, or if it does ring, the call might not connect well when you press **FLASH**. Move closer to the telephone base, then press **FLASH** to answer the call.

If the handset moves out of range during a telephone conversation, there might be interference.

To improve reception, move closer to the telephone base.

Maintenance

Taking care of your telephone

- Your telephone contains sophisticated electronic parts, so it must be treated with care.

Avoid rough treatment

- Place the handset down gently.
- Save the original packing materials to protect your telephone if you ever need to ship it.

Avoid water

- Your telephone can be damaged if it gets wet. Do not use the handset in the rain, or handle it with wet hands. Do not install the telephone base near a sink, bathtub or shower.

Electrical storms

- Electrical storms can sometime cause power surge harmful to electronic equipment. For your own safety, take caution when using electric appliances during storms.

Cleaning your telephone

- Your telephone has a durable plastic casing that should retain its luster for many years. Clean it only with a soft cloth slightly dampened with water or mild soap.
- Do not use excess water or cleaning solvents of any kind.

Remember that electrical appliances can cause serious injury if used when you are wet or standing in water. If the telephone base should fall into water, **DO NOT RETRIEVE IT UNTIL YOU UNPLUG THE POWER CORD AND TELEPHONE LINE CORDS FROM THE WALL**. Then pull the telephone out by the unplugged cords.

Appendix

The RBRC® seal

The RBRC® seal on the nickel-metal hydride battery indicates that VTech Communications, Inc. is voluntarily participating in an industry program to collect and recycle these batteries at the end of their useful lives, when taken out of service within the United States and Canada.

The RBRC® program provides a convenient alternative to placing used nickel-metal hydride batteries into the trash or municipal waste, which may be illegal in your area.

VTech's participation in RBRC® makes it easy for you to drop off the spent battery at local retailers participating in the RBRC® program or at authorized VTech product service centers. Please call **1 (800) 8 BATTERY®** for information on Ni-MH battery recycling and disposal bans/restrictions in your area. VTech's involvement in this program is part of its commitment to protecting our environment and conserving natural resources.

RBRC® and 1 (800) 8 BATTERY® are registered trademarks of Rechargeable Battery Recycling Corporation.



Appendix

FCC, ACTA and IC regulations

FCC Part 15

This equipment has been tested and found to comply with the requirements for a Class B digital device under Part 15 of the Federal Communications Commission (FCC) rules. These requirements are intended to provide reasonable protection against harmful interference in a residential installation. This equipment generates, uses and can radiate radio frequency energy and, if not installed and used in accordance with the instructions, may cause harmful interference to radio communications. However, there is no guarantee that interference will not occur in a particular installation. If this equipment does cause harmful interference to radio or television reception, which can be determined by turning the equipment off and on, the user is encouraged to try to correct the interference by one or more of the following measures:

- Reorient or relocate the receiving antenna.
- Increase the separation between the equipment and receiver.
- Connect the equipment into an outlet on a circuit different from that to which the receiver is connected.
- Consult the dealer or an experienced radio/TV technician for help.

Changes or modifications to this equipment not expressly approved by the party responsible for compliance could void the user's authority to operate the equipment.

This device complies with Part 15 of the FCC rules. Operation is subject to the following two conditions: (1) this device may not cause harmful interference, and (2) this device must accept any interference received, including interference that may cause undesired operation. Privacy of communications may not be ensured when using this telephone.

To ensure safety of users, the FCC has established criteria for the amount of radio frequency energy that can be safely absorbed by a user or bystander according to the intended usage of the product. This product has been tested and found to comply with the FCC criteria. The handset may be safely held against the ear of the user. The telephone base shall be installed and used such that parts of the user's body other than the hands are maintained at a distance of approximately 20 cm (8 inches) or more.

This Class B digital apparatus complies with Canadian requirement:
CAN ICES-3 (B)/NMB-3(B).

FCC Part 68 and ACTA

This equipment complies with Part 68 of the FCC rules and with technical requirements adopted by the Administrative Council for Terminal Attachments (ACTA). The label on the back or bottom of this equipment contains, among other things, a product identifier in the format US:AAAEQ##TXXXX. This identifier must be provided to your local telephone company upon request.

The plug and jack used to connect this equipment to premises wiring and the telephone network must comply with applicable Part 68 rules and technical requirements adopted by ACTA. A compliant telephone cord and modular plug is provided with this product. It is designed to be connected to a compatible modular jack that is also compliant. An RJ11 jack should normally be used for connecting to a single line and an RJ14 jack for two lines. See Installation Instructions in the user's manual.

The Ringer Equivalence Number (REN) is used to determine how many devices you may connect to your telephone line and still have them ring when you are called. The REN for this product is encoded as the 6th and 7th characters following the US: in the product identifier (e.g., if ## is 03, the REN is 0.3).

Appendix

FCC, ACTA and IC regulations

In most, but not all areas, the sum of all RENs should be five (5.0) or less. For more information, please contact your local telephone company.

This equipment may not be used with Party Lines. If you have specially wired alarm dialing equipment connected to your telephone line, ensure the connection of this equipment does not disable your alarm equipment. If you have questions about what will disable alarm equipment, consult your telephone company or a qualified installer.

If this equipment is malfunctioning, it must be unplugged from the modular jack until the problem has been corrected. Repairs to this telephone equipment can only be made by the manufacturer or its authorized agents. For repair procedures, follow the instructions outlined under the Limited warranty.

If this equipment is causing harm to the telephone network, the telephone company may temporarily discontinue your telephone service. The telephone company is required to notify you before interrupting service. If advance notice is not practical, you will be notified as soon as possible. You will be given the opportunity to correct the problem and the telephone company is required to inform you of your right to file a complaint with the FCC. Your telephone company may make changes in its facilities, equipment, operation, or procedures that could affect the proper functioning of this product. The telephone company is required to notify you if such changes are planned.

If this product is equipped with a corded or cordless handset, it is hearing aid compatible.

If this product has memory dialing locations, you may choose to store emergency telephone numbers (e.g., police, fire, medical) in these locations. If you do store or test emergency numbers, please:

Remain on the line and briefly explain the reason for the call before hanging up.

Perform such activities in off-peak hours, such as early morning or late evening.

Industry Canada

Operation is subject to the following two conditions: (1) this device may not cause harmful interference, and (2) this device must accept any interference received, including interference that may cause undesired operation.

Privacy of communications may not be ensured when using this phone.

The term "IC:" before the certification/registration number only signifies that the Industry Canada technical specifications were met.

The Ringer Equivalence Number (REN) for this terminal equipment is 0.1. The REN is an indication of the maximum number of devices allowed to be connected to a telephone interface. The termination on an interface may consist of any combination of devices subject only to the requirement that the sum of the RENs of all the devices does not exceed five.

This product meets the applicable Industry Canada technical specifications.

Appendix

California Energy Commission battery charging testing instructions

This telephone is set up to comply with the energy-conserving standards right out of the box. These instructions are intended for California Energy Commission (CEC) compliance testing only. When the CEC battery charging testing mode is activated, all telephone functions, except battery charging, will be disabled.

To activate the CEC battery charging testing mode:

1. Unplug the telephone base power adapter from the power outlet. Make sure all handsets are plugged with charged batteries.
2. While you press and hold **⏏/FIND HANDSET**, plug the telephone base power adapter back to the power outlet.
3. After about 20 seconds, when the **IN USE** light starts flashing, release **⏏/FIND HANDSET** and then press it again within 2 seconds.



When the phone successfully enters the CEC battery charging testing mode, the **IN USE** light turns off and all handsets display **1.PRESS FIND HS ON BASE 4 SEC** and **2.THEN PRESS # ON HANDSET** alternately.

When the phone fails to enter this mode, repeat Step 1 through Step 3 above.

note

The telephone base will be powered up as normal if you fail to press **⏏/FIND HANDSET** within 2 seconds in Step 3.

To deactivate the CEC battery charging testing mode:

1. Unplug the telephone base adapter from the power outlet, then plug it back in. Then the telephone base is powered up as normal.
2. Press and hold **⏏/FIND HANDSET** on the telephone base for about four seconds until the red **IN USE** light on the telephone base turns on.
3. Press **#** (pound key) on the handset. The handset shows **REGISTERING..... PLEASE WAIT**. The handset shows **HANDSET REGISTERED** and you hear a beep when the registration process completes. This process takes about 60 seconds.

note

- If the registration fails, the handset shows **REGISTRATION FAILED** and then **1.PRESS FIND HS ON BASE 4 SEC** and **2.THEN PRESS # ON HANDSET** alternately. Remove the handset from the telephone base and place it back in. Repeat Steps 1 and 2 again.
- To reset the telephone, unplug the power and the battery for a few seconds then plug them back in.
- Only one handset can register to the telephone base at a time.

Appendix

For C-UL compliance only

Mesures de sécurité importantes

Afin de réduire les risques d'incendie, de blessures corporelles ou d'électrocution, suivez toujours ces mesures préventives de base lorsque vous utilisez votre téléphone :

1. Lisez et comprenez bien toutes les instructions.
2. Observez toutes les instructions et mises en garde inscrites sur l'appareil.
3. Débranchez ce téléphone de la prise murale avant de le nettoyer. N'utilisez pas de nettoyeurs liquides ni en aérosol. N'utilisez qu'un chiffon doux et légèrement humecté.
4. N'utilisez pas ce produit près de l'eau, tel que près d'un bain, d'un lavabo, d'un évier de cuisine, d'un bac de lavage ou d'une piscine, ou dans un sous-sol humide ou sous la douche.
5. Ne déposez pas ce téléphone sur un chariot, support ou table chancelants. L'appareil pourrait tomber et être sérieusement endommagé.
6. Évitez d'installer le système téléphonique dans les endroits soumis à une température extrême, à la lumière directe du soleil ou à proximité immédiate d'autres appareils électriques ou électroniques. Protégez votre téléphone contre les sources d'humidité, la poussière, les vapeurs et les liquides corrosifs.
7. Le boîtier de l'appareil est doté de fentes et d'ouvertures d'aération situées à l'arrière ou en dessous. Afin d'empêcher la surchauffe, ces ouvertures ne doivent pas être obstruées en plaçant l'appareil sur un lit, divan, tapis ou autre surface similaires. Ne placez pas cet appareil à proximité d'un élément de chauffage ni d'une plinthe électrique. De plus, ne l'installez pas dans une unité murale ou un cabinet fermé qui ne possède pas d'aération adéquate.
8. Ne faites fonctionner cet appareil qu'avec le type d'alimentation indiqué sur les étiquettes de l'appareil. Si vous ne connaissez pas le voltage de votre maison, consultez votre marchand ou votre fournisseur d'électricité.
9. Ne déposez rien sur le cordon d'alimentation. Installez cet appareil dans un endroit sécuritaire, là où personne ne pourra trébucher sur la ligne d'alimentation ni le cordon téléphonique modulaire.
10. N'insérez jamais d'objets à travers les fentes et ouvertures de cet appareil, car ils pourraient toucher à des points de tension dangereux ou court-circuiter des pièces, ce qui constituerait un risque d'incendie ou d'électrocution. N'échappez pas de liquides dans l'appareil.
11. Afin de réduire les risques d'électrocution, ne démontez pas l'appareil, mais apportez-le plutôt à un centre de service qualifié s'il doit être réparé. En enlevant le couvercle, vous vous exposez à des tensions dangereuses ou autres dangers similaires. Un remontage inadéquat peut être à l'origine d'une électrocution lors d'une utilisation ultérieure de l'appareil. Débranchez l'appareil avant de procéder au nettoyage. Utilisez un chiffon humide et doux.
12. Ne surchargez pas les prises de courant et les rallonges.
13. Débranchez cet appareil de la prise de courant et communiquez avec le département de service à la clientèle de VTech dans les cas suivants:
 - Lorsque le cordon d'alimentation est endommagé ou écorché.
 - Si du liquide a été échappé dans l'appareil.
 - Si l'appareil a été exposé à une source d'humidité telle que la pluie ou l'eau.
 - Si le produit ne fonctionne pas normalement en respectant les instructions de fonctionnement. Réglez uniquement les commandes indiquées dans les instructions de fonctionnement. Les réglages incorrects des autres commandes pourraient provoquer un dommage qui pourrait exiger un travail exhaustif de la part d'un technicien autorisé afin de rétablir le fonctionnement normal de l'appareil.
 - Si le produit a été échappé et que le socle et/ou le combiné a été endommagé.
 - Si le produit affiche une nette diminution de sa performance.

Appendix

For C-UL compliance only

14. Évitez d'utiliser un téléphone (autre qu'un sans fil) pendant un orage. Les éclairs peuvent être à l'origine d'une électrocution.
15. N'utilisez pas le téléphone pour rapporter une fuite de gaz à proximité de la fuite. En certaines circonstances, une flammèche pourrait être provoquée lorsque l'adaptateur est branché à une prise de courant, ou lorsque le combiné est déposé sur le socle. Ceci est un événement commun associé à la fermeture d'un circuit électrique. L'utilisateur ne devrait pas brancher le téléphone à une prise de courant, et ne devrait pas déposer le combiné chargé sur le socle, si le téléphone se trouve à proximité d'un endroit comportant des concentrations de gaz inflammables, à moins que la ventilation soit adéquate. Une flammèche dans un tel endroit pourrait provoquer un incendie ou une explosion. De tels environnements peuvent comprendre: des endroits où l'on utilise de l'oxygène médical sans ventilation adéquate; des gaz industriels (dissolvants de nettoyage, des vapeurs d'essence, etc.); une fuite de gaz naturel, etc.
16. Ne placez que le combiné de votre téléphone près de votre oreille lorsqu'en mode de conversation.
17. Ces adaptateurs ont été conçus pour être orientés en position verticale ou montés au sol. Les broches ne sont pas conçues pour maintenir l'adaptateur en place si celui-ci est branché dans une prise au plafond ou sous une table/ armoire.

CONSERVEZ CES INSTRUCTIONS

Pile

- MISE EN GARDE : N'utilisez que la pile incluse.
- Ne jetez pas la pile au feu. Vérifiez les instructions spécifiques de mise aux rebus auprès des autorités locales.
- N'ouvrez pas et ne nutilez pas la pile. L'électrolyte qui s'en échapperait est corrosif et pourrait causer des brûlures ou des blessures aux yeux ou à la peau. L'électrolyte est toxique si avalé.
- Soyez prudents lorsque vous manipulez les piles afin d'éviter les courts-circuits provoqués par des matériaux conducteurs.
- Rechargez la pile incluse ou identifiée pour fonctionner avec cet appareil, selon les instructions et limites spécifiées dans ce guide d'utilisation.

Stimulateurs cardiaques implantés dans l'organisme

Les simulateurs cardiaques (s'applique uniquement aux téléphones numériques sans fil) :

L'organisme 'Wireless Technology Research, LLC (WTR)', une firme de recherche indépendante, a mené une évaluation pluridisciplinaire des interférences entre les téléphones sans fil portatifs et les stimulateurs cardiaques implantés dans l'organisme. Appuyée par l'Administration des aliments et drogues (FDA) des États-Unis, la firme WTR recommande aux médecins :

Avis aux détenteurs de stimulateurs cardiaques

- Ils doivent tenir le téléphone sans fil à une distance d'au moins six pouces du stimulateur cardiaque.
- Ils ne doivent PAS placer le téléphone sans fil directement sur le stimulateur cardiaque, tel que dans une poche de chemise, lorsque celui-ci est en marche.
- Ils doivent utiliser le téléphone sans fil en l'appuyant sur l'oreille qui se trouve dans la direction opposée au stimulateur cardiaque.

L'étude effectuée par l'organisme WRS n'a pas identifié de risque pour les détenteurs de simulateurs cardiaques causés par les gens qui utilisent un téléphone sans fil à proximité de ceux-ci.

Appendix

For C-UL compliance only

À propos des téléphones sans fil

- **Confidentialité** : Les mêmes caractéristiques qui constituent des avantages pour les téléphones sans fil affichent également des restrictions. Les appels téléphoniques sont transmis entre le combiné sans fil et le socle par le biais d'ondes radio ; il y a donc la possibilité que vos conversations téléphoniques sans fil soient interceptées par des équipements de réception radio se trouvant dans la portée du combiné sans fil. Pour cette raison, vous ne devez pas percevoir les communications téléphoniques sans fil comme étant aussi confidentielles que celles des téléphones à cordons.
- **Alimentation électrique** : Le socle de ce téléphone sans fil doit être branché à une prise électrique fonctionnelle. La prise électrique ne doit pas être contrôlée par un interrupteur mural. Les appels ne pourront pas être effectués du combiné sans fil si le socle est débranché ou mis hors tension ou si le courant est coupé.
- **Possibilité d'interférences aux téléviseurs** : Certains téléphones sans fil fonctionnent sur des fréquences pouvant causer des interférences aux téléviseurs et aux magnétoscopes. Pour réduire ou prévenir de telles interférences, ne placez pas le socle du téléphone sans fil près ou sur un téléviseur ou magnétoscope. S'il y a présence de parasites, il est conseillé d'éloigner le téléphone sans fil du téléviseur ou du magnétoscope afin de réduire possiblement les interférences.
- **Piles rechargeables** : Manipulez les piles avec soin afin de ne pas les court-circuiter avec des bagues, bracelets ou clés. Les piles ou le conducteur peut surchauffer et causer des blessures. Respectez la polarité adéquate entre la pile et le chargeur.
- **Les bloc-piles rechargeables à l'hydrure métallique de nickel** : Jetez ces blocs-piles de manière écologique et sécuritaire. Ne les incinerez pas et ne les percez pas. Tel que les autres piles de ce type, elles pourraient dégager une matière toxique qui peut causer des blessures corporelles si elles sont brûlées ou percées.

Appendix

Limited warranty

What does this limited warranty cover?

The manufacturer of this VTech Product warrants to the holder of a valid proof of purchase (“Consumer” or “you”) that the Product and all accessories provided in the sales package (“Product”) are free from defects in material and workmanship, pursuant to the following terms and conditions, when installed and used normally and in accordance with the Product operating instructions. This limited warranty extends only to the Consumer for Products purchased and used in the United States of America and Canada.

What will VTech do if the Product is not free from defects in materials and workmanship during the limited warranty period (“Materially Defective Product”)?

During the limited warranty period, VTech’s authorized service representative will repair or replace at VTech’s option, without charge, a Materially Defective Product. If we repair the Product, we may use new or refurbished replacement parts. If we choose to replace the Product, we may replace it with a new or refurbished Product of the same or similar design. We will retain defective parts, modules, or equipment. Repair or replacement of the Product, at VTech’s option, is your exclusive remedy. VTech will return the repaired or replacement Products to you in working condition. You should expect the repair or replacement to take approximately 30 days.

How long is the limited warranty period?

The limited warranty period for the Product extends for ONE (1) YEAR from the date of purchase. If VTech repairs or replaces a Materially Defective Product under the terms of this limited warranty, this limited warranty also applies to repaired or replacement Product for a period of either (a) 90 days from the date the repaired or replacement Product is shipped to you or (b) the time remaining on the original one-year warranty; whichever is longer.

What is not covered by this limited warranty?

This limited warranty does not cover:

1. Product that has been subjected to misuse, accident, shipping or other physical damage, improper installation, abnormal operation or handling, neglect, inundation, fire, water or other liquid intrusion; or
2. Product that has been damaged due to repair, alteration or modification by anyone other than an authorized service representative of VTech; or
3. Product to the extent that the problem experienced is caused by signal conditions, network reliability, or cable or antenna systems; or
4. Product to the extent that the problem is caused by use with non-VTech accessories; or
5. Product whose warranty/quality stickers, product serial number plates or electronic serial numbers have been removed, altered or rendered illegible; or
6. Product purchased, used, serviced, or shipped for repair from outside the United States of America or Canada, or used for commercial or institutional purposes (including but not limited to Products used for rental purposes); or
7. Product returned without a valid proof of purchase (see item 2 on the next page); or
8. Charges for installation or set up, adjustment of customer controls, and installation or repair of systems outside the unit.

Appendix

Limited warranty

How do you get warranty service?

To obtain warranty service, please visit our website www.vtechphones.com, or call 1 (800) 595-9511. In Canada, go to www.vtechcanada.com, or call 1 (800) 267-7377.

NOTE: Before calling for service, please review the user's manual - a check of the Product's controls and features may save you a service call.

Except as provided by applicable law, you assume the risk of loss or damage during transit and transportation and are responsible for delivery or handling charges incurred in the transport of the Product(s) to the service location. VTech will return repaired or replaced Product under this limited warranty. Transportation, delivery or handling charges are prepaid. VTech assumes no risk for damage or loss of the Product in transit. If the Product failure is not covered by this limited warranty, or proof of purchase does not meet the terms of this limited warranty, VTech will notify you and will request that you authorize the cost of repair prior to any further repair activity. You must pay for the cost of repair and return shipping costs for the repair of Products that are not covered by this limited warranty.

What must you return with the Product to get warranty service?

1. Return the entire original package and contents including the Product to the VTech service location along with a description of the malfunction or difficulty; and
2. Include a "valid proof of purchase" (sales receipt) identifying the Product purchased (Product model) and the date of purchase or receipt; and
3. Provide your name, complete and correct mailing address, and telephone number.

Other limitations

This warranty is the complete and exclusive agreement between you and VTech. It supersedes all other written or oral communications related to this Product. VTech provides no other warranties for this Product. The warranty exclusively describes all of VTech's responsibilities regarding the Product. There are no other express warranties. No one is authorized to make modifications to this limited warranty and you should not rely on any such modification.

State/Provincial Law Rights: This warranty gives you specific legal rights, and you may also have other rights, which vary from state to state or province to province.

Limitations: Implied warranties, including those of fitness for a particular purpose and merchantability (an unwritten warranty that the Product is fit for ordinary use) are limited to one year from the date of purchase. Some states/provinces do not allow limitations on how long an implied warranty lasts, so the above limitation may not apply to you. In no event shall VTech be liable for any indirect, special, incidental, consequential, or similar damages (including, but not limited to lost profits or revenue, inability to use the Product or other associated equipment, the cost of substitute equipment, and claims by third parties) resulting from the use of this Product. Some states/provinces do not allow the exclusion or limitation of incidental or consequential damages, so the above limitation or exclusion may not apply to you.

Please retain your original sales receipt as proof of purchase.

Appendix

Technical specifications

Transmit frequency	Handset: 1921.536-1928.448 MHz Telephone base: 1921.536-1928.448 MHz
Channels	5
Nominal effective range	Maximum power allowed by FCC and IC. Actual operating range may vary according to environment conditions at the time of use.
Power requirements	Handset: 2.4V Ni-MH battery Telephone base: 6V DC @ 400mA Charger: 6V AC @ 300mA
Memory	Handset directory: 50 memory locations; up to 30 digits and 15 characters Handset call log: 50 memory locations; up to 24 digits and 15 characters

Index

A

- About cordless telephones 64
- Alphabetical search 29
- Answer a call 18
- Answering system setup 37
- Answer on/off 37

B

- Battery 3–4
- Battery charging 5

C

- Call log 33
- Call screening 39, 42, 43
- Call waiting 19
- Caller ID 32
- Chain dialing 21
- Charger installation 2
- Charging 5
- Create a new directory entry 27–28

D

- Delete a directory entry 29
- Delete a redial entry 20
- Delete from the call log 36
- Delete the announcement 38
- Dial a directory entry 29
- Dial a speed dial number 31
- Dial mode 17
- Directory 26

E

- End a call 18
- Expand your telephone system 52

F

- Find handset 22
- Flash 19

H

- Handset layout 10–11
- Home area code 17

I

- Important safety instructions 61, 62
- Installation 2, 3–4
- Intercom 23–25

J

- Join a call 22

K

- Key tone 15

L

- LCD language 14

M

- Maintenance 63
- Make a call 18
- Memory match 34
- Message alert tone 40
- Message playback 43–44
- Message window displays 47
- Missed call indicator 34
- Mute 19

N

- New message indication 42
- Number of rings 39

P

- Paging handsets 22
- Parts checklist 1
- Precautions for users of implanted cardiac pacemakers 62
- Predial a call 18

Index

R

- Record a new announcement 38
- Remote access 48
- Remote access code 39
- Review directory entries 29
- Review the call log 34
- Ringer 12
- Ringer volume (handset) 13
- Ringer volume (telephone base) 12

S

- Safety instructions 61, 62
- Speakerphone 18
- Store a speed dial entry 30

T

- Technical specifications 73
- Telephone base installation 2
- Telephone base layout 9
- Temporary ringer silencing 19
- Temporary tone dialing 19
- Transfer a call 24
- Troubleshooting 53–60

V

- View dialing options 35
- Vicemail 15, 41
- Voice prompts 42
- Volume 12, 13, 18, 44

W

- Wall mount installation 6
- Warranty 71–72



Designed to fit your home.
And your life.

VTech Communications, Inc.

A member of THE VTECH GROUP OF COMPANIES.

VTech is a registered trademark of VTech Holdings Limited.

Specifications are subject to change without notice.

© 2014 VTech Communications, Inc.

All right reserved. 11/14. CS6429-X_WEBCIB_V9.0

Document order number: 91-007805-010-100

